

Finding and Recognizing Popular Coalition Structures

Felix Brandt Martin Bullinger

Abstract

An important aspect of multi-agent systems concerns the formation of coalitions that are stable or optimal in some well-defined way. The notion of *popularity* has recently received a lot of attention in this context. A partition is popular if there is no other partition in which more agents are better off than worse off. In 2019, a long-standing open problem concerning popularity was solved by proving that computing popular partitions in roommate games is NP-hard, even when preferences are strict. We show that this result breaks down when allowing for randomization: *mixed* popular partitions can be found efficiently via linear programming and a separation oracle. Our result implies that one can efficiently verify whether a given partition in a roommate game is popular and that strongly popular partitions can be found in polynomial time (resolving an open problem). By contrast, we prove that both problems become computationally intractable when moving from coalitions of size 2 to coalitions of size 3, even when preferences are strict and globally ranked. Moreover, we give elaborate proofs showing the NP-hardness of finding popular, strongly popular, and mixed popular partitions in symmetric additively separable hedonic games and symmetric fractional hedonic games.

1 Introduction

Coalitions and coalition formation have been a central concern of game theory, ever since the publication of von Neumann and Morgenstern’s *Theory of Games and Economic Behavior* in 1944. The traditional models of coalitional game theory, in particular TU (transferable utility) and NTU (non-transferable utility) coalitional games, involve a formal specification of what each group of agents can achieve on their own. Drèze and Greenberg (1980) noted that in many situations this is not feasible, possible, or even relevant to the coalition formation process, as, e.g., in the formation of social clubs, teams, or societies. Instead, in coalition formation games, the agents’ preferences are defined directly over the coalition structures, i.e., partitions of the agents in disjoint coalitions. Formally, coalition formation can thus be considered as a special case of the general social choice setting, where the agents entertain preferences over a special type of alternatives, namely coalition partitions of themselves, from which one or more need to be selected. In most situations it is natural to assume that an agent’s appreciation of a partition only depends on the coalition he is a member of and not on how the remaining agents are grouped. Popularized by Bogomolnaia and Jackson (2002), much of the work on coalition formation now concentrates on these so-called *hedonic games*.

The main focus in hedonic games has been on finding and recognizing partitions that satisfy various notions of *stability*—such as Nash stability, individual stability, or core stability—or *optimality*—such as Pareto optimality, utilitarian welfare maximality, or egalitarian welfare maximality (see Aziz and Savani, 2016, for an overview). In this paper, we focus on the notion of *popularity* (Gärdenfors, 1975), which has the flavor of both stability and optimality. A partition is popular if there is no other partition that is preferred by a majority of the agents. Moreover, a partition is strongly popular if it is preferred to every other partition by some majority of agents. Popularity thus corresponds to the notion of weak and strong Condorcet winners in social choice theory, i.e., candidates that are at least

as good as any other candidate in pairwise majority comparisons. Just like stability notions, popularity is based on the idea that a subset of agents breaks off in order to increase their well-being. However, since the new partition has to make at least as many agents better off than worse off, popularity also has the flavor of optimality. According to the standard reference *Algorithmics of Matching Under Preferences*, “popular matchings [...] have been an exciting area of research in the last few years” (Manlove, 2013, p. 333). A recent survey on popular matchings is provided by Cseh (2017).

In contrast to Pareto optimal partitions, popular partitions are not guaranteed to exist. We therefore also consider *mixed* popular partitions, as proposed by Kavitha et al. (2011) and whose existence follows from the Minimax Theorem. A mixed popular partition is a probability distribution over partitions p such that there is no other mixed partition q such that the expected number of agents who prefer the partition returned by p to q is at least as large as the other way round. Mixed popular partitions are a special case of *maximal lotteries*, a randomized voting rule that has recently gathered increased attention in social choice theory (Fishburn, 1984; Brandl et al., 2016; Brandl and Brandt, 2020; Brandl et al., 2018).

We study the computational complexity of popular, strongly popular, and mixed popular partitions in a variety of hedonic coalition formation settings including additively separable hedonic games, fractional hedonic games as well as hedonic games where the coalition size is bounded. The latter includes flatmate games (which only allow coalitions of up to three agents) and roommate games (which only allow coalitions of up to two agents). Our main findings are as follows.

- Generalizing earlier results by Kavitha et al. (2011), we show how mixed popular partitions in roommate games can be computed in polynomial time via linear programming and a separation oracle on a subpolytope of the matching polytope for non-bipartite graphs.¹ This stands in contrast to a recent result showing that computing popular partitions in roommate games is NP-hard (Faenza et al., 2019; Gupta et al., 2019).
- As corollaries we obtain that verifying popular partitions (Biró et al., 2010), finding Pareto optimal partitions (Aziz et al., 2013a), and finding strongly popular partitions can all be done in polynomial time in roommate games, even when preferences admit ties. The latter statement resolves an acknowledged open problem.²
- We provide the first negative computational results for mixed popular partitions and strongly popular partitions by showing that finding these partitions in flatmate games is NP-hard. Moreover, it turns out, that verifying whether a given partition is popular, strongly popular, or mixed popular in flatmate games is coNP-complete. All of these results hold for strict and globally ranked preferences, where coalitions appear in the same order in each individual preference ranking. This is interesting insofar as finding popular partitions in roommate games becomes tractable under the same restrictions.
- We prove that computing popular, strongly popular, and mixed popular partitions is NP-hard in symmetric additively separable hedonic games and symmetric fractional hedonic games. Furthermore, we show coNP-completeness of all corresponding verification problems.

¹The results by Kavitha et al. (2011) only hold for house allocation and marriage markets and cannot be straightforwardly extended to roommate markets. See Section 2 for more details.

²See, for example, Biró et al. (2010) and Manlove (2013): “A third open problem is the complexity of finding a strongly popular matching (or reporting that none exists), for an instance of RPT [Roommate Problem with Ties]” (Biró et al., 2010, p. 107); “Our last open problem concerns the complexity of the problem of finding a strongly popular matching, or reporting that none exists, given an instance of SRTI [Stable Roommates with Ties and Incomplete lists], which is unknown at the time of writing” (Manlove, 2013, p. 380).

2 Related Work

Gärdenfors (1975) first proposed the notions of popularity and strong popularity in the context of marriage games. He showed that popular matchings (or “majority assignments” in his terminology) need not exist when preferences are weak, but that existence is guaranteed for strict preferences because every stable matching is popular. As a consequence, the well-known Gale-Shapley algorithm efficiently identifies popular matchings in marriage games with strict preferences. Kavitha and Nasre (2009), Huang and Kavitha (2011), and Kavitha (2014) provide efficient algorithms for computing popular matchings that satisfy additional properties such as rank maximality or maximum cardinality. For weak preferences, computing popular matchings is NP-hard, even when all agents belonging to one side have strict preferences (Biró et al., 2010; Cseh et al., 2015).

In the more restricted setting of house allocation (henceforth housing games), Abraham et al. (2007) proposed efficient algorithms for finding popular allocations of maximum cardinality for both weak and strict preferences. Mahdian (2006) proved an interesting threshold for the existence of popular allocations: if there are n agents and the number of houses exceeds αn with $\alpha \approx 1.42$, then the probability that there is a popular allocation converges to 1 as n goes to infinity.

For roommate games with weak preferences, NP-hardness of computing popular matchings follows from the above-mentioned hardness results for marriage games. It was recently shown that this problem is still NP-hard when preferences are strict (Gupta et al., 2019; Faenza et al., 2019; Cseh and Kavitha, 2018). Also, finding a maximum-cardinality popular matching in instances where popular matchings are guaranteed to exist is NP-hard (Brandl and Kavitha, 2018).

There are less results on *strongly* popular matchings. It is known from Gärdenfors (1975) that a strongly popular matching has to be a unique popular matching and that every strongly popular matching is stable in roommate and marriage games. Based on these insights, Biró et al. (2010) showed that strongly popular matchings in roommate games and marriage games with strict preferences can be found efficiently by first computing an arbitrary stable matching and then checking whether it is strongly popular. The case of weak preferences was left open and little progress has been made since then. Király and Mészáros-Karkus (2017) recently gave an algorithm for finding strongly popular matchings in marriage games where preferences are strict, except that agents belonging to one side may be completely indifferent. In housing games, a matching is strongly popular if and only if it is a unique perfect matching. Hence, strongly popular matchings in housing games can be found in polynomial time. All of the above mentioned results on strong popularity, including the open problem, follow from our Corollary 3.

Mixed popular matchings were introduced by Kavitha et al. (2011) who also showed how to compute a *fractional* popular matching in housing games and marriage games, which can then be translated into a mixed popular matching via a Birkhoff-von Neumann decomposition. This is possible in these bipartite settings because every fractional matching is implementable as a probability distribution over deterministic matchings. When moving from marriage markets to roommate markets, this does not hold anymore. For example, a matching involving three agents where every pair of agents is matched with probability $1/2$ is not implementable. Huang and Kavitha (2017) have shown that in marriage games with strict preferences, the popular matching polytope is half-integral and that half-integral mixed popular matchings can be computed in polynomial time. No such matchings are guaranteed to exist when preferences are weak. They also apply the same techniques to roommate games in order to compute an optimal half-integral solution over the bipartite matching polytope in the case of strict preferences. However, the resulting solutions may again fail to be implementable. Apart from that, their methods heavily rely on computing

stable matchings, which may be intractable when preferences are weak. By contrast, our results in Section 4.2.1 are based on the matching polytope for non-bipartite graphs via odd-set constraints and allow both to deal with ties and to efficiently compute a solution that is implementable using LP methods (Proposition 5). The axiomatic properties of mixed popular matchings such as efficiency and strategyproofness were investigated by Aziz et al. (2013c), Brandt et al. (2017), and Brandl et al. (2017).

To the best of our knowledge, popularity, strong popularity, and mixed popularity have not been studied for coalition formation settings that go beyond coalitions of size 2 except for a theorem by Aziz et al. (2013b, Th. 15) who claimed that checking whether a partition is popular in ASGHs is NP-hard and that verifying whether a partition is popular is coNP-complete. However, the proof of the first statement is incorrect.³ We substantially modified the reduction to prove a stronger statement and independently proved a stronger statement for the verification problem.

3 Preliminaries

Let N be a finite set of agents. A *coalition* is a non-empty subset of N . By \mathcal{N}_i we denote the set of coalitions agent i belongs to, i.e., $\mathcal{N}_i = \{S \subseteq N : i \in S\}$. A *coalition structure*, or simply a *partition*, is a partition π of the agents N into coalitions, where $\pi(i)$ is the coalition agent i belongs to. A *hedonic game* is a pair (N, \succsim) , where $\succsim = (\succsim_i)_{i \in N}$ is a *preference profile* specifying the preferences of each agent i as a complete and transitive *preference relation* \succsim_i over \mathcal{N}_i . If \succsim_i is also anti-symmetric we say that i 's preferences are *strict*. Otherwise, we say that preferences are *weak*. We denote by $S \succ_i T$ if $S \succsim_i T$ but not $T \succsim_i S$ —i.e., i *strictly prefers* S to T —and by $S \sim_i T$ if both $S \succsim_i T$ and $T \succsim_i S$ —i.e., i is *indifferent* between S and T . In hedonic games, agents are only concerned about their own coalition. Accordingly, preferences over coalitions naturally extend to preferences over partitions as follows: $\pi \succsim_i \pi'$ if and only if $\pi(i) \succsim_i \pi'(i)$.

Sometimes, we consider strict preferences, which are obtained from weak preferences by breaking ties arbitrarily. To express such preferences succinctly, given a set X of alternatives, we denote by X^\succ an arbitrary, but fixed strict preference order of the alternatives in X . For example, $a \succ \{b, c\}^\succ \succ d$ could be replaced by $a \succ b \succ c \succ d$. For simplicity, one can assume that ties are broken lexicographically. When referring to index sets, such as sets of players, we use the shorthand $[k]$ for $\{1, \dots, k\}$ and $[k, l]$ for $\{k, \dots, l\}$.

Two basic properties of partitions are Pareto optimality and individual rationality. Given a hedonic game (N, \succsim) , a partition π is *Pareto optimal* if there is no partition π' such that $\pi' \succ_j \pi$ for all agents j and $\pi' \succ_i \pi$ for at least one agent i . A coalition $S \in \mathcal{N}_i$ is *individually rational* for agent i if she prefers the coalition to staying alone, i.e., $S \succsim_i \{i\}$. A Partition π is *individually rational* if $\pi(i) \succsim_i \{i\}$ for all $i \in N$. The rationale behind individual rationality is that agents cannot be forced into a coalition.

Individual rationality is also the crucial ingredient of a succinct representation of hedonic games where only the preferences over individual rational coalitions are considered (Ballester, 2004). A hedonic game (N, \succsim) is represented by *Individually Rational Lists of Coalitions* (IRLC) via the game (N, \succsim') where \succsim' is a preference profile such that \succsim'_i is the restriction of \succsim_i to individually rational coalitions in \mathcal{N}_i . In this case, (N, \succsim) is called a *completion* of (N, \succsim') . This representation of games is useful to obtain meaningful hardness results because the size of the naive representation of a hedonic game is exponential in the number of agents while the IRLC representation may only require polynomial space if the

³The reduction fails because for a ‘yes’-instance of Exact 3-Cover, the partition π claimed to be popular for the ASHG it maps to is not popular: the partition $\pi' = \{\{y^s, z_1^s, z_2^s\} : s \in S\} \cup \{\{b_1^r, a_2^r\} : r \in R\} \cup \{\{b_2^r, a_1^r, a_3^r\} : r \in R\}$ is more popular.

number of individually rational coalitions is small enough.

In order to define popularity and strong popularity, let $N(\pi, \pi')$ be the set of agents who prefer π over π' , i.e., $N(\pi, \pi') = \{i \in N : \pi(i) \succ_i \pi'(i)\}$, where π, π' are two partitions of N . For any subset $M \subseteq N$ of agents and partitions π, π' of N , $\phi_M(\pi, \pi') = |N(\pi, \pi') \cap M| - |N(\pi', \pi) \cap M|$ is called the *popularity margin on M with respect to π and π'* . If $M = \{i\}$ is a singleton set, we use the shorthand notation ϕ_i instead of $\phi_{\{i\}}$. On top of that, we define the *popularity margin* of π and π' as $\phi(\pi, \pi') = \phi_N(\pi, \pi')$. Then, π is called *more popular* than π' if $\phi(\pi, \pi') > 0$. Furthermore, π is called *popular* if, for all partitions π' , $\phi(\pi, \pi') \geq 0$, i.e., no partition is more popular than π . π is called *strongly popular* if, for all partitions $\pi' \neq \pi$, $\phi(\pi, \pi') > 0$, i.e., π is more popular than every other partition. Note that there can be at most one strongly popular partition in any hedonic game.

For a hedonic game (N, \succ) in IRLC representation, a partition π is called *popular* if it is popular in the completion of (N, \succ) where, for each agent, all coalitions that are not individually rational are gathered in a single indifference class that is less preferred than the singleton coalition. This definition of popularity generalizes the definition of popularity that is used for marriage games by Kavitha et al. (2011), and adds the appropriate perspective on individual rationality.⁴ Note that a popular partition need not be individually rational.

Many hedonic games do not admit a popular partition. However, existence can be guaranteed by introducing randomization via mixed partitions, i.e., probability distributions over partitions. Let two mixed partitions $p = \{(\pi_1, p_1), \dots, (\pi_k, p_k)\}$ and $q = \{(\sigma_1, q_1), \dots, (\sigma_l, q_l)\}$ be given, where $(p_1, \dots, p_k), (q_1, \dots, q_l)$ are probability distributions. We define the popularity margin of p and q as their expected popularity margin, i.e.,

$$\phi(p, q) = \sum_{i=1}^k \sum_{j=1}^l p_i q_j \phi(\pi_i, \sigma_j).$$

Clearly, the definition of popularity carries over to the extension of ϕ . As first observed by Kavitha et al. (2011), mixed popular partitions always exist, because they can be interpreted as maximin strategies of a symmetric zero-sum game (see also Fishburn, 1984; Aziz et al., 2013c). Due to space constraints, we defer most of the proofs to the appendix.

Proposition 1. *Every hedonic game admits a mixed popular partition.*

4 Results

Our results are divided into three subsections. We first show some basic properties of and relationships between the different notions of popularity and then analyze popularity in ordinal hedonic games (such as flatmate and roommate games) and cardinal hedonic games (such as additively separable and fractional hedonic games).

4.1 Basic Relationships

Clearly, a strongly popular partition is also popular and a popular partition, interpreted as a probability distribution with singleton support, is mixed popular. Furthermore, every

⁴The IRLC representation ignores preferences over coalitions that are not individually rational. However, in contrast to core stability or Nash stability, these preferences can affect whether a partition is popular or not. In order to circumvent this problem one could strengthen the definition of popularity by requiring that a coalition needs to be popular for *all* extensions of the IRLC represented preferences. All our results also hold for this notion, because we construct individually rational partitions for which the two notions of popularity coincide.

coalition structure in the support of a mixed popular partition is Pareto optimal. This already follows from a more general statement by Fishburn (1984, Prop. 3). For completeness, we give a simple proof in the appendix.

Proposition 2. *Let $p = \{(\pi_1, p_1), \dots, (\pi_k, p_k)\}$ be a mixed popular partition. Then, for every $i \in [k]$ with $p_i > 0$, π_i is Pareto optimal.*

We thus have the following relationships between strong popularity (sPop), popularity (Pop), partitions in the support of any mixed popular partition (supp(mPop)), and Pareto optimality (PO):

$$\text{sPop} \implies \text{Pop} \implies \mathbf{\text{supp(mPop)}} \implies \mathbf{\text{PO}}.$$

The concepts printed in boldface are guaranteed to exist. As a consequence, hardness results for computing Pareto optimal partitions imply hardness of computing mixed popular partitions (though not for popular partitions since they need not exist). Mixed popular partitions also satisfy probabilistic strengthenings of Pareto optimality based on stochastic dominance and pairwise comparisons (Aziz et al., 2018).

The existence problems for popular and strongly popular partitions are naturally contained in the complexity class Σ_2^P . The verification problems are contained in coNP. The following relationship turns out to be helpful for deducing the complexity of verifying mixed popular partitions from the respective result for popular partitions.

Proposition 3. *Let a class of hedonic games be given such that the verification problem of popular partitions is coNP-hard. Then, the verification problem of mixed popular partitions is coNP-complete.*

Hence, whenever hardness results are obtained for the verification of popularity, they transfer automatically to mixed popularity. Conversely, polynomial-time algorithms for mixed popularity can be used to efficiently verify whether a partition is popular.

Popular partitions are not only Pareto optimal, but it also suffices to compare a partition against Pareto optimal partitions when checking for popularity. This is useful when proving popularity of a given partition, for example in hardness reductions.

Proposition 4. *A partition π is popular if and only if, for all Pareto optimal partitions π' , $\phi(\pi, \pi') \geq 0$. In addition, π is strongly popular if and only if, for all Pareto optimal partitions $\pi' \neq \pi$, $\phi(\pi, \pi') > 0$.*

4.2 Ordinal Hedonic Games

In this section we investigate hedonic games in IRLC representation. Important subclasses of these games are defined by restricting the size of individually rational coalitions using a global constant. We thus obtain *flatmate games* as games in which only coalitions of up to three agents are individually rational and *roommate games* as games in which only coalitions of size 2 are individually rational. More restrictions are obtained by partitioning the set of agents into two groups, say, into males and females, and even further by additionally demanding that one group of agents is completely indifferent, say, by assuming that they are objects such as houses. A *marriage game* is a roommate game where the agents can be partitioned in two sets such that the only individually rational partitions are formed with agents from the other set. A *housing game* is a marriage game where all agents belonging to one set of the partition are completely indifferent. All of these classes permit polynomially bounded IRLC representations and form the following inclusion relationship.⁵

$$\text{Housing} \subsetneq \text{Marriage} \subsetneq \text{Roommates} \subsetneq \text{Flatmates} \subsetneq \text{IRLC}.$$

⁵Note that the inclusion between housing games and marriage games does not hold for strict preferences.

In roommate games (and their subclasses), partitions are referred to as *matchings*.

Finally we consider a severe preference restriction in coalition formation in general. A preference profile admits *globally ranked preferences* if there exists one common global ranking \succsim of all coalitions in $2^N \setminus \{\emptyset\}$ and each individual preference relation \succsim_i is the restriction of \succsim to \mathcal{N}_i .

Under globally ranked preferences, the intractability of computing popular matchings in roommate games with strict preferences (Gupta et al., 2019; Faenza et al., 2019; Cseh and Kavitha, 2018) breaks down. In fact, it is known that under these preferences, every roommate game admits a stable matching, which can furthermore be efficiently computed (Abraham et al., 2008). Since every stable matching also happens to be popular (see Section 2), this implies that computing popular matchings in roommate games becomes tractable. By contrast, all hardness results for flatmate games that will be shown in Section 4.2.2 hold even when preferences are globally ranked. This confirms the robustness of these results and underlines the crucial difference between settings with coalitions of size 2 and coalitions of size 3.

Hedonic games in IRLC representation that also happen to be globally ranked are quite restricted. In particular, a coalition C needs to be either individually rational for all agents in C or for none. The global ranking of coalitions can therefore be compactly represented by omitting all coalitions C that are ranked below any of the singleton coalitions consisting of one of the members of C . Any such coalition is Pareto dominated and therefore irrelevant for popularity (Proposition 4).

4.2.1 Roommate Games

We start by investigating mixed popularity in roommate games, which will later have important consequences for popular and strongly popular matchings.

Kavitha et al. (2011) showed that mixed popular matchings in housing games and marriage games can be found in polynomial time. However, as explained in Section 2, their algorithm cannot be applied to roommate games. In this section, we show how to obtain an algorithm for the more general class of roommate games.

To introduce our matching notation, we fix a graph $G = (N, E)$ where the vertex set is the set of agents and there is an edge between two vertices if the corresponding coalition of size 2 is individually rational for both agents. For technical reasons, it is useful to restrict attention to the case of perfect matchings, i.e., matchings in which every vertex is matched with some vertex. Similarly to the construction by Kavitha et al. (2011), this can be achieved by introducing worst-case partners w_a for every agent a with $\{a, w_a\} \sim_a \{a\}$. These worst-case partners are not individually rational for all other original agents, and are indifferent among all other agents themselves. They mimic the case when an agent remains unmatched and do not affect the popularity of a partition. In graph-theoretic terms, this is equivalent to adding a loop to every vertex. If some loop is contained in a perfect matching, this means that the agent is matched to herself, or in other words, remains unmatched.

We now establish a relationship between mixed matchings and fractional matchings, where the latter are defined as points in the (perfect) matching polytope $P_{Mat} \subseteq [0, 1]^E$, defined as follows (Edmonds, 1965).

$$P_{Mat} = \{x \in \mathbb{R}^E : \sum_{e \in E, v \in e} x(e) = 1 \forall v \in N, \\ \sum_{e \in \{\{v, w\} \in E : v, w \in C\}} x(e) \leq \frac{|C| - 1}{2} \forall C \subseteq N, |C| \text{ odd}, \\ x(e) \geq 0 \forall e \in E\}$$

The main constraint is often called *odd set constraint* and ensures that, for every odd set of agents C , the weight of the fractional matching restricted to these agents is at most $(|C| - 1)/2$, where this quantity is equal to the maximum cardinality that any matching on the set C may have.

The key insight is to extend the concept of the popularity margin to fractional matchings. With this notion, we can refine the matching polytope to obtain the popularity polytope

$$P_{Pop} = \{x \in P_{Mat} : \phi(x, \chi_M) \geq 0 \text{ for all matchings } M\}.$$

There, χ_M denotes the incidence vector corresponding to matching M . The feasible points of P_{Pop} correspond exactly to mixed popular matchings. Solving the separation problem and showing how to extract a mixed matching, we obtain the next theorem.

Theorem 1. *Mixed popular matchings in roommate games with weak preferences can be found in polynomial time.*

The technical details are provided in the appendix. Theorem 1 has a number of interesting consequences. Since every mixed popular matching is Pareto optimal, we now have an LP-based algorithm to find Pareto optimal matchings for weak preferences as an alternative to combinatorial algorithms like the Preference Refinement Algorithm by Aziz et al. (2013a).

Corollary 1. *Pareto optimal matchings in roommate games with weak preferences can be found in polynomial time.*

Biró et al. (2010) provided a sophisticated algorithm for verifying whether a given matching is popular. An efficient LP-based algorithm for this problem follows from Theorem 1.

Corollary 2. *It can be verified in polynomial time whether a given matching in a roommate game is popular.*

Finally, the linear programming approach allows us to resolve the open problem of finding strongly popular matchings when preferences are weak.

Corollary 3. *Finding a strongly popular matching or deciding that no such matching exists in roommate games with weak preferences can be done in polynomial time.*

It follows from the proof that the verification problem for strongly popular matchings in roommate games can also be solved efficiently.

4.2.2 Flatmate Games

It turns out that moving from coalitions of size 2 to size 3 renders all search problems related to popular partitions intractable. For mixed popular partitions, we can leverage the relationship to Pareto optimal partitions. Aziz et al. (2013a, Th. 5) have shown that finding Pareto optimal partitions in flatmate games with weak preferences is NP-hard. Since mixed popular partitions are guaranteed to exist (Proposition 1) and satisfy Pareto optimality (Proposition 2), this immediately implies the NP-hardness of computing mixed popular partitions by means of a Turing reduction.⁶

Theorem 2. *Computing a partition in the support of a mixed popular partition in flatmate games with weak preferences is NP-hard.*

⁶Using the same argument, one can transfer further results on Pareto optimality (Aziz et al., 2013a), e.g., for room-roommate games or three-cyclic matching games.

For strict preferences, the same method does not work. Pareto optimal partitions can always be found efficiently by serial dictatorship. Therefore, we will give direct reductions that yield hardness under strict preferences. In our approach, we show that the class of flatmate games under strict preferences is sufficiently rich to contain games satisfying a certain set of properties. These properties allow to deduce a wide range of hardness results. The proof strategy is very generic and is key to many hardness reductions for cardinal hedonic games in Section 4.3.

Consider the NP-complete problem X3C (Karp, 1972). An instance (R, S) of *Exact 3-Cover* (X3C) consists of a ground set R together with a set S of 3-element subsets of R . A ‘yes’-instance is an instance such that there exists a subset $S' \subseteq S$ that partitions R . We say that a class of games satisfies *property R* (for reduction) if there exists a polynomial-time reduction from X3C that constructs for every instance (R, S) a game (N, \succ) together with a special agent $x \in N$, and a partition π^* such that for every partition $\pi \neq \pi^*$, it holds that

1. $\phi(\pi^*, \pi) \geq 1$,
2. if $\pi^*(x) \cap \pi(x) = \{x\}$, then $\phi(\pi^*, \pi) \geq 3$ or (R, S) is a ‘yes’-instance,
3. for all $y \in N$, $\pi^*(y) \succ_y \{y\}$, and
4. $\pi^*(x) \succ_x C$ for all $C \in \mathcal{N}_x \setminus \{\pi^*(x)\}$.

In addition, if (R, S) is a ‘yes’-instance, then there exists a partition π' with

5. $\phi(\pi^*, \pi') = 1$, and
6. $\pi'(x) = \{x\}$.

The first condition guarantees that π^* is strongly popular and with the second condition, strong popularity is unaffected when adding one or two auxiliary agents that only have an effect on x . The third condition is only needed for the proofs concerning fractional hedonic games with non-negative utility functions, but it also holds for all other classes investigated. It does ensure that every agent is part of an individually rational coalition, and in fact prefers her coalition in π^* over staying alone. The fourth condition says that x is in her unique top-ranked coalition under the partition π^* . The last two properties ensure that we can obtain a more popular partition by adding auxiliary agents that form a new coalition with x .

Lemma 1. *The class of flatmate games under strict and globally ranked preferences satisfies property R.*

By introducing some auxiliary agents, and possibly using the game in the lemma multiple times as a gadget, we obtain a wide range of hardness results. Still, a lot of the technical work is deferred to the appendix.

Theorem 3. *Consider the class of flatmate games with strict and globally ranked preferences. Then, the following statements are true:*

- *Deciding whether there exists a popular partition is coNP-hard.*
- *Deciding whether there exists a strongly popular partition is coNP-hard.*
- *Computing a mixed popular partition is NP-hard.*
- *Verifying whether a given partition is popular is coNP-complete.*
- *Verifying whether a given partition is strongly popular is coNP-complete.*

An interesting observation concerns the relationship of existence and verification problems. Our general proof strategy for the coNP-hardness of existence problems is to give an instance of a game *together with* a partition that is (strongly) popular if and only if the constructed game arises from a ‘no’-instance of the NP-hard source problem. If the game is based on a ‘yes’-instance, there is no (strongly) popular partition. In other words, all relevant questions on (strong) popularity can be answered with this given partition.

Consequently, we actually prove coNP-hardness for a restriction of the verification problem that is only allowed to ask for verification of partitions that have to be (strongly) popular if such a partition exists. Clearly, the hardness of this restricted problem implies both hardness of the verification and the existence problem. The latter follows from the simple reduction that maps tuples (G, π) of a game and a partition to the game G . Instead of giving the reduction for this unifying problem, we prefer not to introduce this restricted verification problem, and to keep the focus on the problems that we are actually interested in. However, the same phenomenon will occur again for the proofs regarding cardinal hedonic games in the next section.

4.3 Cardinal Hedonic Games

Important subclasses of hedonic games that admit succinct representations are based on cardinal utility functions. For one, there are *additively separable hedonic games* (Bogomolnaia and Jackson, 2002), where the utility that an agent associates with a coalition is the sum of utilities he ascribes to each member of the coalition. On the other hand, there are *fractional hedonic games* (Aziz et al., 2019), where the sum of utilities is divided by the number of agents contained in the coalition.

In the following, let $v_i(j)$ denote the utility that agent i associates with agent j . Based on these utilities and the underlying class of games, we will deduce the utility $v_i(S)$ that i associates with some coalition $S \in \mathcal{N}_i$. The preferences of i over two coalitions $S, T \in \mathcal{N}_i$ are then given by assuming that $S \succsim_i T$ if and only if $v_i(S) \geq v_i(T)$. A hedonic game (N, \succsim) is an *additively separable hedonic game* (ASHG) if there is $(v_i(j))_{i,j \in N}$ that for every agent i , the preferences \succsim_i are induced by the cardinal utilities given by $v(S) = \sum_{j \in S} v_i(j)$. The hedonic game (N, \succsim) is a *fractional hedonic game* (FHG) if there exists $(v_i(j))_{i,j \in N}$ such that for every agent i , the preferences \succsim_i are induced by the cardinal utilities given by $v(S) = (\sum_{j \in S} v_i(j))/|S|$, for $S \subseteq N$. We focus on *symmetric* ASHG and FHGs, i.e., games for which $v_i(j) = v_j(i)$ for all $i, j \in N$ and denote the symmetric utilities by $v(i, j) = v_i(j) = v_j(i)$.

As the proof strategies are very similar for ASHG and FHGs, we state theorems always for both classes, even though we give separate proofs in the appendix. Most of the time, reductions for FHGs tend to be more complicated versions than the ones for ASHG, because utility functions are not additive. On top of that, negative utilities have very different consequences in ASHG and FHGs. In ASHG with non-negative utility functions, the grand coalition will form under any set of reasonable assumptions because it is the best possible coalition for all agents. The same is not true for FHGs, which incentivize small coalitions by having the size of a coalition in the denominator of utility functions. Hence, in contrast to ASHG, FHGs are meaningful in the absence of negative utilities and it is therefore desirable to prove hardness results that even hold for non-negative utilities. All hardness results in this section are obtained by rather involved reductions from X3C.

In the appendix, we provide examples of ASHG and FHGs that do not admit popular partitions, which are used as gadgets for the next two results (cf. Proposition 9 and Proposition 11).

Theorem 4. *Checking whether there exists a popular partition is NP-hard in symmetric ASHG and symmetric FHGs with non-negative utilities.*

Theorem 5. *Checking whether a given partition is popular is coNP-complete in a symmetric ASHG and symmetric and bipartite FHGs with non-negative utilities.*

The graphs used in the part about FHGs have girth 6. This is in contrast to the polynomial-time algorithm by Aziz et al. (2019) for computing the core in FHGs with girth at least 5.

The reductions for coNP-hardness of mixed and strong popularity as well as popularity rely on the idea of property R which we already employed in Lemma 3. The next lemma establishes this property and is subsequently applied to prove the next four theorems. Note that it is not possible to leverage the relationship of mixed popularity and Pareto optimality, because Pareto optimal partitions can be found in polynomial time for symmetric ASHGs (Bullinger, 2020).

Lemma 2. *The class of symmetric ASHGs and the class of symmetric FHGs with non-negative utilities satisfy property R.*

Theorem 6. *Checking whether there exists a strongly popular partition is coNP-hard in symmetric ASHGs and symmetric FHGs with non-negative utilities.*

Theorem 7. *Verifying whether a given partition is strongly popular is coNP-complete in symmetric ASHGs and symmetric FHGs with non-negative utilities.*

Theorem 8. *Computing a mixed popular partition is NP-hard in symmetric ASHGs and symmetric FHGs with non-negative utilities.*

We even obtain coNP-hardness of the existence of popular partitions which makes it unlikely that this problem is in NP (otherwise $\text{coNP} = \text{NP}$) and, together with Theorem 4, might be seen as evidence that this problem is even Σ_2^P -complete.

Theorem 9. *Checking whether there exists a popular partition is coNP-hard in symmetric ASHGs and symmetric FHGs with non-negative utilities.*

5 Conclusion

We have investigated the computational complexity of finding and recognizing popular, strongly popular, and mixed popular partitions in various types of ordinal hedonic games and cardinal hedonic games. Table 1 summarizes our results and gives an overview of the complexity for computing a respective partition. There, NP-hardness refers to intractability of the corresponding search problem, which follows directly from NP-hardness or coNP-hardness of the existence problem via a Turing reduction. Note that both NP-hardness and coNP-hardness of the existence problem for popularity hold for flatmate game, ASHGs, and FHGs, where the NP-hardness for flatmate games follows from the hardness for roommate games. It is open whether these problems are even Σ_2^P -complete. Whenever we obtain hardness of an existence problem, the corresponding verification problem is coNP-complete. For mixed popularity, this follows from Proposition 3.

Two important factors that govern the complexity of computing these partitions in ordinal hedonic games are whether preferences may contain ties and whether coalitions of size 3 are allowed. When preferences are weak, computing mixed popular and strongly popular partitions is only difficult for representations for which we cannot even compute Pareto optimal partitions efficiently. For strict preferences, however, Pareto optimal partitions can be found efficiently while computing popular, mixed popular, and strongly popular partitions

	<i>weak preferences</i>				<i>strict preferences</i>			
	PO	mPop	sPop	Pop	PO	mPop	sPop	Pop
IRLC								
Flatmates	NP-h. ^a	NP-h. (Th. 2)	NP-h. (Th. 10)		in P	NP-h. (Th. 11)	NP-h. (Th. 10)	
Roommates	in P ^b	in P (Th. 1)	in P (Cor. 3)			in P (Th. 1)	in P ^d	NP-h. ^g
Marriage				NP-h. ^e				in P ^f
Housing				in P ^c	in P	in P ^h	in P	in P ^c

	PO	PO/IR	mPop	sPop	Pop
symmetric ASHG	in P ^j	NP-h. ^j	NP-h. (Th. 19)	NP-h. (Th. 17)	NP-h. (Th. 15, 20)
symmetric FHGs	in P (0/1) ^j	NP-h. ^j	NP-h. (Th. 25)	NP-h. (Th. 23)	NP-h. (Th. 21, 26)

Table 1: Complexity of finding popular and Pareto optimal partitions in various classes of hedonic games. New results are highlighted in gray and implications are marked by gray arrows. NP-hardness of computing a popular or strongly popular partition always follows by a Turing reduction from the existence problem. Pareto optimal partitions in FHGs can be computed in polynomial time for (0/1)-preferences.

^a: Aziz et al. (2013a, Th. 5), ^b: Aziz et al. (2013a, Th. 7), ^c: Abraham et al. (2007, Th. 3.9), ^d: Biró et al. (2010, Th. 6), ^e: Biró et al. (2010, Th. 11), Cseh et al. (2015, Th. 2), ^f: Gärdenfors (1975, Th. 3), ^g: Gupta et al. (2019, Th. 1.1), Faenza et al. (2019, Th. 4.6), Cseh and Kavitha (2018, Th. 2), ^h: Kavitha et al. (2011, Th. 2); the result by Kavitha et al. holds for marriage games and weak preferences; these are implied by our Th. 1; ^j: Bullinger (2020, Th. 5.1, 5.1, 6.2, 6.4)

remains intractable. These results are quite robust and all results for flatmate games hold even when preferences are globally ranked, while this restriction allows for tractability of popularity under strict preferences in roommate games. It can be shown that our hardness results remain intact for tripartite matching (with strict and globally ranked preferences), where the agents can be partitioned into three groups and individually rational coalitions may only contain at most one agent of each group. An interesting avenue for future research is to consider further restrictions such as room-roommate games or three-cyclic matchings.

Our positive results for roommate games are obtained via a single linear programming approach that unifies a number of existing results and exploits the relationships between the different types of popularity. On the other hand, both in flatmate games and cardinal hedonic games, our hardness results are based on the same central idea, formalized as property R. All of these classes of hedonic games contain games with a strongly popular partition together with an agent that can govern the switch between strong popularity and non-popularity by joining different sets of additional auxiliary agents. As a consequence, results for all types of popularity and for both existence and verification problems can be extracted from the same reduction.

Acknowledgments

This material is based on work supported by the Deutsche Forschungsgemeinschaft under grant BR 2312/12-1. The authors thank Stefan Weltge and three anonymous reviewers for providing valuable feedback.

Preliminary results of this paper were presented at the 19th International Conference on Autonomous Agents and Multi-Agent Systems (May, 2020).

References

- D. J. Abraham, A. Leravi, D. F. Manlove, and G. O'Malley. The stable roommates problem with globally ranked pairs. *Internet Mathematics*, 5(4):493–515, 2008.
- D. K. Abraham, R. W. Irving, T. Kavitha, and K. Mehlhorn. Popular matchings. *SIAM Journal on Computing*, 37(4):1030–1034, 2007.
- H. Aziz and R. Savani. Hedonic games. In F. Brandt, V. Conitzer, U. Endriss, J. Lang, and A. D. Procaccia, editors, *Handbook of Computational Social Choice*, chapter 15. Cambridge University Press, 2016.
- H. Aziz, F. Brandt, and P. Harrenstein. Pareto optimality in coalition formation. *Games and Economic Behavior*, 82:562–581, 2013a.
- H. Aziz, F. Brandt, and H. G. Seedig. Computing desirable partitions in additively separable hedonic games. *Artificial Intelligence*, 195:316–334, 2013b.
- H. Aziz, F. Brandt, and P. Stursberg. On popular random assignments. In *Proceedings of the 6th International Symposium on Algorithmic Game Theory (SAGT)*, volume 8146 of *Lecture Notes in Computer Science (LNCS)*, pages 183–194. Springer-Verlag, 2013c.
- H. Aziz, F. Brandl, F. Brandt, and M. Brill. On the tradeoff between efficiency and strategyproofness. *Games and Economic Behavior*, 110:1–18, 2018.
- H. Aziz, F. Brandl, F. Brandt, P. Harrenstein, M. Olsen, and D. Peters. Fractional hedonic games. *ACM Transactions on Economics and Computation*, 7(2):1–29, 2019.
- C. Ballester. NP-completeness in hedonic games. *Games and Economic Behavior*, 49(1):1–30, 2004.
- P. Biró, R. W. Irving, and D. F. Manlove. Popular matchings in the marriage and roommates problems. In *Proceedings of the 7th Italian Conference on Algorithms and Complexity (CIAC)*, pages 97–108, 2010.
- A. Bogomolnaia and M. O. Jackson. The stability of hedonic coalition structures. *Games and Economic Behavior*, 38(2):201–230, 2002.
- F. Brandl and F. Brandt. Arrovian aggregation of convex preferences. *Econometrica*, 88(2):799–844, 2020.
- F. Brandl and T. Kavitha. Two problems in max-size popular matchings. *Algorithmica*, 81(7):2738–2764, 2018.
- F. Brandl, F. Brandt, and H. G. Seedig. Consistent probabilistic social choice. *Econometrica*, 84(5):1839–1880, 2016.
- F. Brandl, F. Brandt, and J. Hofbauer. Random assignment with optional participation. In *Proceedings of the 16th International Conference on Autonomous Agents and Multiagent Systems (AAMAS)*, pages 326–334, 2017.
- F. Brandl, F. Brandt, and C. Stricker. An analytical and experimental comparison of maximal lottery schemes. In *Proceedings of the 27th International Joint Conference on Artificial Intelligence (IJCAI)*, pages 114–120, 2018.
- F. Brandt, J. Hofbauer, and M. Suderland. Majority graphs of assignment problems and properties of popular random assignments. In *Proceedings of the 16th International Conference on Autonomous Agents and Multiagent Systems (AAMAS)*, pages 335–343, 2017.

- M. Bullinger. Pareto-optimality in cardinal hedonic games. In *Proceedings of the 19th International Conference on Autonomous Agents and Multiagent Systems (AAMAS)*, pages 213–221, 2020.
- A. Cseh. Popular matchings. In U. Endriss, editor, *Trends in Computational Social Choice*, chapter 6. AI Access, 2017.
- Á. Cseh and T. Kavitha. Popular matchings in complete graphs. In *Proceedings of the 37th IARCS Annual Conference on Foundations of Software Technology and Theoretical Computer Science (FSTTCS)*, 2018.
- Á. Cseh, C.-C. Huang, and T. Kavitha. Popular matchings with two-sided preferences and one-sided ties. In *Proceedings of the 42nd International Colloquium on Automata, Languages, and Programming (ICALP)*, volume 9134 of *Lecture Notes in Computer Science (LNCS)*, pages 367–379. Springer-Verlag, 2015.
- J. H. Drèze and J. Greenberg. Hedonic coalitions: Optimality and stability. *Econometrica*, 48(4):987–1003, 1980.
- J. Edmonds. Maximum matching and a polyhedron with 0,1-vertices. *Journal of Research of the National Bureau of Standards B*, 69:125–130, 1965.
- Y. Faenza, T. Kavitha, V. Power, and X. Zhang. Popular matchings and limits to tractability. In *Proceedings of the 30th Annual ACM-SIAM Symposium on Discrete Algorithms (SODA)*, pages 2790–2809, 2019.
- P. C. Fishburn. Probabilistic social choice based on simple voting comparisons. *Review of Economic Studies*, 51(4):683–692, 1984.
- P. Gärdenfors. Match making: Assignments based on bilateral preferences. *Behavioral Science*, 20(3):166–173, 1975.
- M. Grötschel, L. Lovász, and A. Schrijver. The ellipsoid method and its consequences in combinatorial optimization. *Combinatorica*, 1:169–197, 1981.
- S. Gupta, P. Misra, S. Saurabh, and M. Zehavi. Popular matching in roommates setting is np-hard. In *Proceedings of the 30th Annual ACM-SIAM Symposium on Discrete Algorithms (SODA)*, pages 2810–2822, 2019.
- C.-C. Huang and T. Kavitha. Popular matchings in the stable marriage problem. In *Proceedings of the 38th International Colloquium on Automata, Languages, and Programming (ICALP)*, volume 6755 of *Lecture Notes in Computer Science (LNCS)*, pages 666–677. Springer-Verlag, 2011.
- C.-C. Huang and T. Kavitha. Popularity, mixed matchings, and self-duality. In *Proceedings of the 28th Annual ACM-SIAM Symposium on Discrete Algorithms (SODA)*, pages 2294–2310, 2017.
- R. M. Karp. Reducibility among combinatorial problems. In R. E. Miller and J. W. Thatcher, editors, *Complexity of Computer Computations*, pages 85–103. Plenum Press, 1972.
- T. Kavitha. A size-popularity tradeoff in the stable marriage problem. *SIAM Journal on Computing*, 43(1):52–71, 2014.
- T. Kavitha and M. Nasre. Optimal popular matchings. *Discrete Applied Mathematics*, 157:3181–3186, 2009.

- T. Kavitha, J. Mestre, and M. Nasre. Popular mixed matchings. *Theoretical Computer Science*, 412(24):2679–2690, 2011.
- L. Khachiyan. A polynomial algorithm in linear programming. *Soviet Mathematics Doklady*, 20:191–194, 1979.
- T. Király and Z. Mészáros-Karkus. Finding strongly popular b -matchings in bipartite graphs. *Electronic Notes in Discrete Mathematics*, 61:735–741, 2017.
- M. Mahdian. Random popular matchings. In *Proceedings of the 7th ACM Conference on Electronic Commerce (ACM-EC)*, pages 238–242, 2006.
- D. F. Manlove. *Algorithmics of Matching Under Preferences*. World Scientific Publishing Company, 2013.
- R. M. McCutchen. The least-unpopularity-factor and least-unpopularity-margin criteria for matching problems with one-sided preferences. In *Proceedings of the 8th Latin American Conference on Theoretical Informatics (LATIN)*, volume 4957 of *Lecture Notes in Computer Science (LNCS)*, pages 593–604, 2008.
- M. W. Padberg and L. A. Wolsey. Fractional covers for forests and matchings. *Mathematical Programming*, 29:1–14, 1984.
- J. von Neumann. Zur Theorie der Gesellschaftspiele. *Mathematische Annalen*, 100(1):295–320, 1928.
- J. von Neumann and O. Morgenstern. *Theory of Games and Economic Behavior*. Princeton University Press, 2nd edition, 1947.

A Appendix: Proofs

This appendix contains all omitted proofs.

A.1 Basic Results

We start with the basic results.

Proposition 1. *Every hedonic game admits a mixed popular partition.*

Proof. Every hedonic game can be viewed as a finite two-player symmetric zero-sum game where the rows and columns of the two players are indexed by all possible partitions $\pi_1, \dots, \pi_{B_{|N|}}$ and the entry at position (i, j) of the game matrix is $\phi(\pi_i, \pi_j)$. By the Minimax Theorem (von Neumann, 1928), the value of this game is 0 and therefore, any maximin strategy, whose existence is guaranteed, is popular. \square

Proposition 2. *Let $p = \{(\pi_1, p_1), \dots, (\pi_k, p_k)\}$ be a mixed popular partition. Then, for every $i \in [k]$ with $p_i > 0$, π_i is Pareto optimal.*

Proof. Let $p = \{(\pi_1, p_1), \dots, (\pi_k, p_k)\}$ be a mixed popular partition and fix $i \in [k]$ such that $p_i > 0$. Assume for contradiction that π'_i is a Pareto improvement over π_i . Define $p' = \{(\pi_1, p_1), \dots, (\pi_{i-1}, p_{i-1}), (\pi'_i, p_i), (\pi_{i+1}, p_{i+1}), \dots, (\pi_k, p_k)\}$. Note that $\phi(\pi'_i, p) = \sum_{j=1, j \neq i}^k p_j \phi(\pi'_i, \pi_j) + p_i \phi(\pi'_i, \pi_i) \geq \sum_{j=1, j \neq i}^k p_j \phi(\pi_i, \pi_j) + p_i \phi(\pi'_i, \pi_i) > \sum_{j=1, j \neq i}^k p_j \phi(\pi_i, \pi_j) + p_i \phi(\pi_i, \pi_i) = \phi(\pi_i, p)$.

Then, $\phi(p', p) = \sum_{j=1, j \neq i}^k p_j \phi(\pi_j, p) + p_i \phi(\pi'_i, p) > \sum_{j=1, j \neq i}^k p_j \phi(\pi_j, p) + p_i \phi(\pi_i, p) = \phi(p, p) = 0$.

Hence, p is not mixed popular, a contradiction. \square

Proposition 3. *Let a class of hedonic games be given such that the verification problem of popular partitions is coNP-hard. Then, the verification problem of mixed popular partitions is coNP-complete.*

Proof. Let \mathcal{C} be a class of hedonic games and let (G, π) be an instance of the deterministic verification problem, i.e. $G \in \mathcal{C}$ is a hedonic game and π a partition of the agents of G . By linearity of $\pi' \mapsto \phi(\pi, \pi')$, π is popular if, and only if, it is mixed popular. Hence, the embedding of the deterministic into the mixed case gives the desired reduction for coNP-hardness.

For membership in coNP, we observe that whenever there exists a more popular mixed coalition, then also a more popular deterministic one that can serve as a polynomial-size certificate for a ‘no’-instance. Indeed, if p is a mixed partition on a game G and $p' = \{(\pi'_1, p'_1), \dots, (\pi'_k, p'_k)\}$ is more popular, then $0 < \phi(p', p) = \sum_{i=1}^k p'_i \phi(\pi'_i, p)$. Consequently, for some $i \in [k]$, $\phi(\pi'_i, p) > 0$. \square

Proposition 4. *A partition π is popular if and only if, for all Pareto optimal partitions π' , $\phi(\pi, \pi') \geq 0$. In addition, π is strongly popular if and only if, for all Pareto optimal partitions $\pi' \neq \pi$, $\phi(\pi, \pi') > 0$.*

Proof. We show that the respective popularity margin with Pareto optimal partition determine popularity.

This follows from the fact that for every two partitions $\pi, \hat{\pi}$, and a Pareto optimal Pareto improvement π' of $\hat{\pi}$, it holds that $\phi(\pi, \hat{\pi}) \geq \phi(\pi, \pi')$. If we investigate strong popularity, it can happen that $\pi' = \pi$, but in this case $\phi(\pi, \hat{\pi}) > 0$ by Pareto dominance. \square

A.2 Ordinal Hedonic Games

We split the section into roommate and flatmate games.

A.2.1 Roomate games

We show now how to establish the correspondence between mixed and fractional matchings.

Given a matching M , denote by $\chi_M \in P_{Mat}$ its incidence vector. We obtain a correspondence of mixed matchings and fractional matchings by mapping a mixed matching $p = \{(M_1, p_1), \dots, (M_k, p_k)\}$ to the fractional matching $x_p = \sum_{i=1}^k p_i \chi_{M_i}$. Note that $x_p \in P_{Mat}$ by convexity. Since we only want to operate on the more concise matching polytope, we need to ensure that we can recover a mixed matching efficiently. The following proposition, which is based on general LP theory, can be seen as an extension of the Birkhoff-von Neumann theorem to non-bipartite graphs.

Proposition 5. *Let $G = (N, E)$ be a graph and $x \in P_{Mat}$ a vector in the associated matching polytope. Then, a mixed matching $p = \{(M_1, p_1), \dots, (M_k, p_k)\}$ such that $x_p = x$ can be found in polynomial time.*

Proof. The separation problem for the matching polytope P_{Mat} can be solved in polynomial time, i.e., the class of matching polytopes is solvable. Therefore, given a graph $G = (N, E)$ and a vector $x \in P_{Mat}$ we can find a convex combination of extreme points of P_{Mat} that yield x in polynomial time (Grötschel et al., 1981, Th. 3.9). A combinatorial algorithm to address this problem was proposed by Padberg and Wolsey (1984).

Since the extreme points of the matching polytope are the incidence vectors of matchings (Edmonds, 1965), this is a mixed matching whose corresponding fractional matching is x . \square

To be able to operate on fractional matchings only, we seek to define popularity of fractional matchings equivalently to popularity of mixed matchings that induce them. Popular fractional matchings can be described as feasible points of a (non-empty) subpolytope of the matching polytope. The separation problem for the subpolytope can be solved efficiently using a modification of McCutchen's (2008) algorithm for determining the unpopularity margin of a matching.

To this end, we need to define the popularity margin for fractional matchings. Given $x, y \in P_{Mat}$, we define their *popularity margin* as

$$\phi(x, y) = \sum_{a \in N} \sum_{i, j \in N_G(a)} x(a, i) y(a, j) \phi_a(i, j)$$

where $N_G(a) = \{v \in N : \{v, a\} \in E\}$ is the neighborhood of a in G and

$$\phi_a(i, j) = \begin{cases} 1 & \text{if } i \succ_a j \\ -1 & \text{if } i \prec_a j \\ 0 & \text{if } i \sim_a j \end{cases}$$

Imagine that the matchings x and y independently match agent a to agent i and j with probability $x(a, i)$ and $y(a, j)$, respectively. Then, we can interpret the quantity $x(a, i) y(a, j) \phi_a(i, j)$ as the probability of agent a being matched to i through x and to j through y times the characteristic function of agent a 's binary preference between these two matching partners. Then, $\sum_{i, j \in N_G(a)} x(a, i) y(a, j) \phi_a(i, j)$ is the expected preference of agent a between matchings x and y , and $\phi(x, y)$ is the expected popularity margin of the preferences of all agents.

Next, we relate the popularity margins of both worlds. The proof of the proposition is identical to the corresponding statement for marriage games by Kavitha et al. (2011). For the sake of self-containment, we state their proof. Before, we introduce a useful notation for the next two propositions. Given a matching M and an agent a , denote by $M(a)$ the agent, a is matched with.

Proposition 6. *Let p and q be mixed matchings. Then,*

$$\phi(p, q) = \phi(x_p, x_q).$$

In particular, p is popular if and only if for all matchings M , $\phi(x_p, \chi_M) \geq 0$.

Proof. Let p and q be two mixed matchings. By extending them with some matchings of probability 0, we may assume that both are defined on the same set of matchings M_1, \dots, M_k as $p = \{(M_1, p_1), \dots, (M_k, p_k)\}$ and $q = \{(M_1, q_1), \dots, (M_k, q_k)\}$. We derive that

$$\begin{aligned} \phi(p, q) &= \sum_{s,t=1}^k p_s q_t \phi(M_s, M_t) \\ &= \sum_{s,t=1}^k p_s q_t \sum_{a \in N} \phi_a(M_s(a), M_t(a)) \\ &= \sum_{s,t=1}^k p_s q_t \sum_{a \in N} \sum_{i,j \in N_G(a)} \chi_{M_s}(a, i) \chi_{M_t}(a, j) \phi_a(i, j) \\ &= \sum_{a \in N} \sum_{i,j \in N_G(a)} \left(\sum_{s=1}^k p_s \chi_{M_s}(a, i) \right) \left(\sum_{t=1}^k q_t \chi_{M_t}(a, j) \right) \phi_a(i, j) \\ &= \sum_{a \in N} \sum_{i,j \in N_G(a)} x_p(a, i) x_q(a, j) \phi_a(i, j) \\ &= \phi(x_p, x_q). \end{aligned}$$

This proves the desired equality. \square

As a consequence, mixed popular matchings correspond precisely to the feasible points of the polytope

$$P_{Pop} = \{x \in P_{Mat} : \phi(x, \chi_M) \geq 0 \text{ for all matchings } M\}.$$

It remains to find a feasible point of the popularity polytope P_{Pop} . By adopting the auxiliary graph in McCutchen's algorithm for non-bipartite graphs, we can find a matching M minimizing $\phi(x, \chi_M)$ by solving a maximum weight matching problem. This solves the separation problem for P_{Pop} .

Proposition 7. *The separation problem for P_{Pop} can be solved in polynomial time.*

Proof. Assume that a vector $x \in \mathbb{R}^E$ is given. The separation problem for the matching polytope can be solved in polynomial time. For the popularity constraints, we assign weights w_x to the edges of the underlying graph such that for all matchings M on G , $w_x(M) = \phi(\chi_M, x)$. Therefore, their separation problem turns into finding a maximum weight matching, which can be done in polynomial time.

We define the weights by letting

$$w_x(i, j) = \sum_{a \in N_G(i)} x(i, a) \phi_i(j, a) + \sum_{a \in N_G(j)} x(j, a) \phi_j(i, a)$$

and compute

$$\begin{aligned} \phi(\chi_M, x) &= \sum_{a \in N} \sum_{i, j \in N_G(a)} \chi_M(a, i) x(a, j) \phi_a(i, j) \\ &= \sum_{a \in N} \sum_{i, j \in N_G(a)} \chi_M(a, i) x(a, j) \phi_a(i, j) \\ &= \sum_{a \in N} \sum_{j \in N_G(a), i=M(a)} x(a, j) \phi_a(i, j). \end{aligned}$$

On the other hand,

$$\begin{aligned} w_x(M) &= \sum_{\{i, j\} \in M} \left[\sum_{b \in N_G(i)} x(i, b) \phi_i(j, b) + \sum_{b \in N_G(j)} x(j, b) \phi_j(i, b) \right] \\ &= \sum_{\{i, j\} \in M} \left[\sum_{b \in N_G(i), j=M(i)} x(i, b) \phi_i(j, b) + \sum_{b \in N_G(j), i=M(j)} x(j, b) \phi_j(i, b) \right] \\ &= \sum_{a \in N, a \text{ matched}} \sum_{j \in N_G(a), i=M(a)} x(a, j) \phi_a(i, j) \\ &= \sum_{a \in N} \sum_{j \in N_G(a), i=M(a)} x(a, j) \phi_a(i, j) \end{aligned}$$

The last equation is due to the fact that the inner sum is empty for unmatched agents in M . Putting everything together, we conclude that $\phi(\chi_M, x) = w_x(M)$, which completes the proof. \square

We are now ready to prove the following theorem.

Theorem 1. *Mixed popular matchings in roommate games with weak preferences can be found in polynomial time.*

Proof. By Proposition 7 and by means of the Ellipsoid method (Khachiyan, 1979), we can find a fractional popular matching in polynomial time. This can be translated into a mixed popular matching by leveraging Proposition 5. \square

We also provide the proof for its last corollary.

Corollary 3. *Finding a strongly popular matching or deciding that no such matching exists in roommate games with weak preferences can be done in polynomial time.*

Proof. If a strongly popular matching exists, it is unique. In particular, it is the unique mixed popular matching. Given a (deterministic) matching M , we can check in polynomial time if it is strongly popular. Simply apply the reduction of Proposition 7 and check whether the maximum weight matching amongst the matchings different to M on the auxiliary graph has negative weight (in which case the matching is strongly popular) or not. To this end, we compute a maximum weight matching for every (incomplete) graph that is obtained by

deleting exactly one edge from the auxiliary graph. The maximum weight matching amongst these matchings has the highest weight amongst matchings different from M .

The algorithm to compute a strongly popular matching if one exists first computes a fractional popular matching. If it does not correspond to a deterministic matching, there exists no strongly popular matching. Otherwise, it is deterministic and, as described above, we can check if it is strongly popular. If this is the case, we return it. If not, there exists no strongly popular matching. \square

A.2.2 Flatmate games

Instead of giving a direct proof of Lemma 1, we will proceed in several steps. We will first describe the flatmate games, then prove a key property towards establishing the first set of requirements for property R in Lemma 3, and then provide a lemma for global rankedness of the game. Finally, we provide several reductions that—between the lines—establish the second part of property R.

To this end, consider an instance (R, S) of X3C. Let $k = \min\{k \in \mathbb{N} : 2^k \geq |R|\}$ be the smallest power of 2 that is larger than the cardinality of R . We define a flatmate game on vertex set $N = \bigcup_{j=0}^k N_j$, where $N_j = \bigcup_{i=1}^{2^j} A_j^i$ consists of 2^j sets of agents A_j^i .

We define the sets of agents as

- $A_k^i = \{a_k^i, b_k^i, c_k^i\}$ for $i \in [|R|]$,
- $A_k^i = \{a_k^i, b_k^i, c_k^i, y_1^i, y_2^i\}$ for $i \in [|R| + 1, 2^k]$, and
- $A_j^i = \{a_j^i, b_j^i, c_j^i, \alpha_j^i, \beta_j^i, \gamma_j^i, \delta_j^i\}$ for $j \in [0, k - 1], i \in [2^j]$.

Similar names of agents suggest that these agents are going to play the same role in the reduction. The preferences are designed in a way such that if there exists no 3-partition of R through sets in S , then there exists a unique best partition that assigns more than half of the agents a top-ranked coalition. Otherwise, there exists a partition that puts exactly all the other agents in one of their top coalitions. We order the set R in an arbitrary but fixed way, say $R = \{r^1, \dots, r^{|R|}\}$ and for a better understanding of the proof and the preferences, we label the agents $b_k^i = r^i$ for $i \in [|R|]$. If we view the set of agents N as $k + 1$ levels of agents, then the ground set R of the instance of X3C is identified with some specific agents in the top level k . Preferences of the agents are as follows. Recall that X^\succ denotes an arbitrary, but fixed strict preference order of the alternatives in X . We define

- $\{y_1^i, y_2^i\} \succ_{y_1^i} \{y_1^i\}$, $i \in [|R| + 1, 2^k]$,
- $\{b_k^i, y_2^i\} \succ_{y_2^i} \{y_1^i, y_2^i\} \succ_{y_2^i} \{y_2^i\}$, $i \in [|R| + 1, 2^k]$,
- $\{a_k^i, b_k^i, c_k^i\} \succ_{a_k^i} \{a_k^i, a_k^{i+1}, \delta_{k-1}^{(i+1)/2}\} \succ_{a_k^i} \{a_k^i\}$, $i \in [2^k]$ odd,
- $\{a_k^i, b_k^i, c_k^i\} \succ_{a_k^i} \{a_k^i, a_k^{i-1}, \delta_{k-1}^{i/2}\} \succ_{a_k^i} \{a_k^i\}$, $i \in [2^k]$ even,
- $\{a_j^i, \beta_j^i, \gamma_j^i\} \succ_{a_j^i} \{a_j^i, b_j^i, c_j^i\} \succ_{a_j^i} \{a_j^i\}$, $j \in [0, k - 1], i \in [2^j]$,
- $\{\{b_k^i, b_k^v, b_k^w\} : \{r^i, r^v, r^w\} \in S \text{ for some } v, w \in [|R|]\}^\succ \succ_{b_k^i} \{a_k^i, b_k^i, c_k^i\} \succ_{b_k^i} \{b_k^i\}$, $i \in [|R|]$,
- $\{b_k^i, y_2^i\} \succ_{b_k^i} \{a_k^i, b_k^i, c_k^i\} \succ_{b_k^i} \{b_k^i\}$, $i \in [|R| + 1, 2^k]$,
- $\{b_j^i, c_{j+1}^{2i-1}, c_{j+1}^{2i}\} \succ_{b_j^i} \{a_j^i, b_j^i, c_j^i\} \succ_{b_j^i} \{b_j^i\}$, $j \in [0, k - 1], i \in [2^j]$,

- $\{a_j^i, b_j^i, c_j^i\} \succ_{c_j^i} \{c_j^i, c_j^{i+1}, b_{j-1}^{(i+1)/2}\} \succ_{c_j^i} \{c_j^i\}$, $j \in [k], i \in [2^j]$ odd,
- $\{a_j^i, b_j^i, c_j^i\} \succ_{c_j^i} \{c_j^i, c_j^{i-1}, b_{j-1}^{i/2}\} \succ_{c_j^i} \{c_j^i\}$, $j \in [k], i \in [2^j]$ even,
- $\{a_0^1, b_0^1, c_0^1\} \succ_{c_0^1} \{c_0^1\}$,
- $\{\alpha_j^i, \beta_j^i\} \succ_{\alpha_j^i} \{\alpha_j^i, \alpha_j^{i+1}, \delta_{j-1}^{(i+1)/2}\} \succ_{\alpha_j^i} \{\alpha_j^i\}$, $j \in [k-1], i \in [2^j]$ odd,
- $\{\alpha_j^i, \beta_j^i\} \succ_{\alpha_j^i} \{\alpha_j^i, \alpha_j^{i-1}, \delta_{j-1}^{i/2}\} \succ_{\alpha_j^i} \{\alpha_j^i\}$, $j \in [k-1], i \in [2^j]$ even,
- $\{\alpha_0^1, \beta_0^1\} \succ_{\alpha_0^1} \{\alpha_0^1\}$,
- $\{\beta_j^i, \gamma_j^i, a_j^i\} \succ_{\beta_j^i} \{\beta_j^i, \alpha_j^i\} \succ_{\beta_j^i} \{\beta_j^i\}$, $j \in [0, k-1], i \in [2^j]$,
- $\{\gamma_j^i, \delta_j^i\} \succ_{\gamma_j^i} \{\beta_j^i, \gamma_j^i, a_j^i\} \succ_{\gamma_j^i} \{\gamma_j^i\}$, $j \in [0, k-1], i \in [2^j]$,
- $\{\delta_j^i, \alpha_{j+1}^{2i-1}, \alpha_{j+1}^{2i}\} \succ_{\delta_j^i} \{\delta_j^i, \gamma_j^i\} \succ_{\delta_j^i} \{\delta_j^i\}$, $j \in [0, k-2], i \in [2^j]$, and
- $\{\delta_{k-1}^i, \alpha_k^{2i-1}, \alpha_k^{2i}\} \succ_{\delta_{k-1}^i} \{\delta_{k-1}^i, \gamma_{k-1}^i\} \succ_{\delta_{k-1}^i} \{\delta_{k-1}^i\}$, $i \in [2^{k-1}]$.

The structure of the flatmate game is illustrated in Figure 1 for the case $k = 3$. We will be particularly interested in coalitions of the types $\{a_j^i, b_j^i, c_j^i\}$, $\{\alpha_j^i, \beta_j^i\}$, $\{\gamma_j^i, \delta_j^i\}$, and $\{y_1^i, y_2^i\}$ which are marked by undirected edges. These coalitions form the partition π^* of Lemma 3 that we need later to investigate for strong and mixed popularity in the respective reductions. The directed edges indicate that an agent at the tail of the arrow needs to form a coalition with the agent at the tip of the arrow in order to improve from her coalition of the above type. The ground structure of the set of agents can be viewed as a binary tree of triangles depicted by the circular-shaped vertices. The important property of this tree is that whenever a coalition of the type $\{a_j^i, b_j^i, c_j^i\}$ gets dissolved, there can only be an improvement in popularity for the agents in A_j^i if they propagate changes in the partition upwards within this tree. This is achieved for agents b_j^i directly through the binary tree and for agents a_j^i with help of the auxiliary agents $\{\alpha_j^i, \beta_j^i, \gamma_j^i, \delta_j^i\}$ that are depicted as diamond-shaped vertices.

Lemma 3. *Let an instance (R, S) of X3C be given and define the corresponding flatmate game as above. Consider the partition $\pi^* = \{\{a_j^i, b_j^i, c_j^i\}: j \in [0, k], i \in [2^j]\} \cup \{\{\alpha_j^i, \beta_j^i\}, \{\gamma_j^i, \delta_j^i\}: j \in [0, k-1], i \in [2^j]\} \cup \{\{y_1^i, y_2^i\}: i \in [|R| + 1, 2^k]\}$. Let $\pi \neq \pi^*$ be an arbitrary partition of agents distinct from π^* . Then $\phi(\pi^*, \pi) \geq 1$. In addition, if $c_0^1 \in N(\pi^*, \pi)$, then $\phi(\pi^*, \pi) \geq 3$ or $\{b_k^i: i \in [2^k]\} \subseteq N(\pi, \pi^*)$.*

Proof. Let an instance (R, S) of X3C be given and define the corresponding flatmate game as above. Let π^* be defined as in the lemma and $\pi \neq \pi^*$ another partition. We recursively define the following sets of agents: for $i \in [2^k]$, $T_k^i = A_k^i$ and for $j = k-1, \dots, 0, i \in [2^j]$, $T_j^i = A_j^i \cup T_{j+1}^{2i-1} \cup T_{j+1}^{2i}$. We will prove the following claim by induction over $j = k, \dots, 0$.

For every $i \in [2^j]$ holds: Assume there exists an agent $x \in T_j^i$ with $\pi(x) \neq \pi^*(x)$. Then $\phi_{T_j^i}(\pi^*, \pi) \geq 1$. If even $\pi(a_j^i) \neq \pi^*(a_j^i)$, then $\phi_{T_j^i}(\pi^*, \pi) \geq 3 \vee \{b_k^i: i \in [2^k]\} \cap T_j^i \subseteq N(\pi, \pi^*)$.

Note that the claim implies $\phi_{T_j^i}(\pi^*, \pi) \geq 0$ in any case. Clearly, the assertion of the lemma follows from the case $j = 0$.

We frequently use the facts that for all $j \in [0, k-1], i \in [2^j]$,

- $\alpha_j^i \notin N(\pi, \pi^*)$ and if $\beta_j^i \in N(\pi, \pi^*)$, then $\alpha_j^i \in N(\pi^*, \pi)$, and

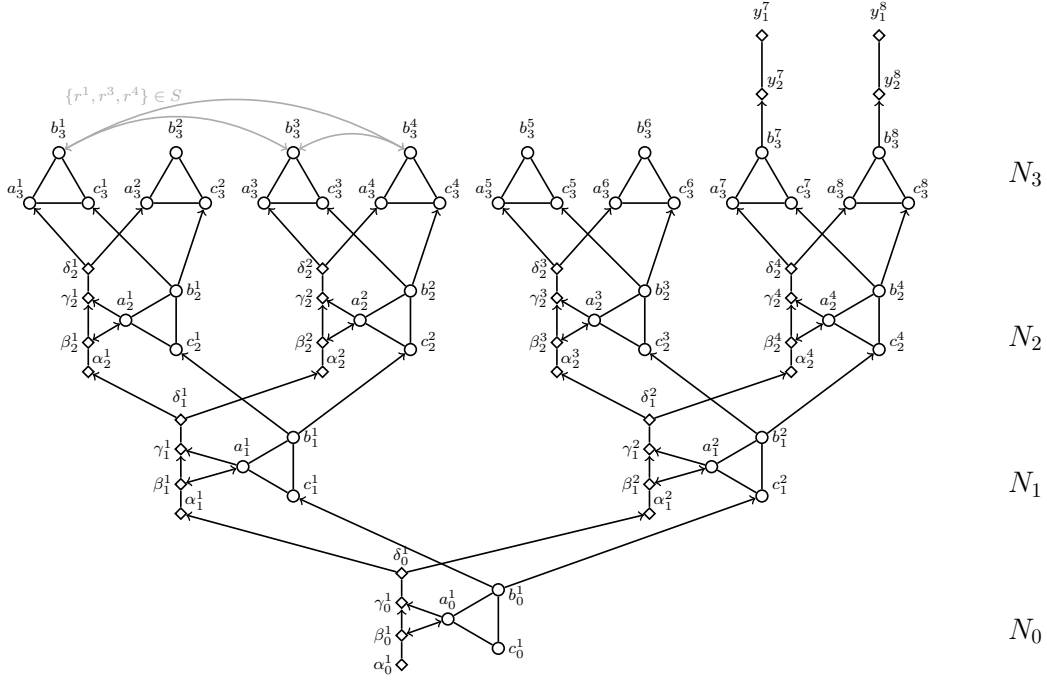

Figure 1: Schematic of the reduction for flatmate games with strict preferences. There is an edge between two agents if they are in the coalition π^* defined in Lemma 3. Directed edges indicate improvements from π^* . The gray edges suggest a 3-elementary set in S .

- $\gamma_j^i \notin N(\pi, \pi^*)$ and if $\delta_j^i \in N(\pi, \pi^*)$, then $\gamma_j^i \in N(\pi^*, \pi)$.

The case $j = k$ and $i \in [2^k]$ is immediate (using a similar fact for agents y_1^i and y_2^i in the case $i \in \{|R| + 1, \dots, 2^k\}$).

For the induction step, let $j \in \{k-1, \dots, 0\}$ and fix $i \in [2^j]$. We will essentially prove that changing the coalitions in A_j^i causes severe loss in popularity, unless we propagate changes to substructures via b_j^i or δ_j^i . Assume first that there exists an agent $x \in T_j^i$ with $\pi(x) \neq \pi^*(x)$ but no such agent in A_j^i . Then, $x \in T_{j+1}^{2i-1} \vee x \in T_{j+1}^{2i}$ and the claim follows by induction. Assume therefore that there exists an agent $x \in A_j^i$ with $\pi(x) \neq \pi^*(x)$. Note that $\phi_{A_j^i}(\pi, \pi^*) \leq 1$.

First consider the case that $\pi(a_j^i) \neq \pi^*(a_j^i)$. If $b_j^i \in N(\pi, \pi^*)$, we can apply induction for T_{j+1}^{2i-1} and T_{j+1}^{2i} and we are done, because by induction $\phi_{T_{j+1}^{2i-1} \cup T_{j+1}^{2i}}(\pi^*, \pi) \geq 4 \vee \{b_k^i : i \in [2^k]\} \cap (T_{j+1}^{2i-1} \cup T_{j+1}^{2i}) \subseteq N(\pi, \pi^*)$. We may therefore assume that $b_j^i \in N(\pi^*, \pi)$. Then, $\phi_{A_j^i}(\pi^*, \pi) \geq 3$ or $a_j^i \in N(\pi, \pi^*)$. In the latter case, $\phi_{A_j^i}(\pi^*, \pi) \geq 3$ unless $\delta_j^i \in N(\pi, \pi^*)$. Finally, if $\delta_j^i \in N(\pi, \pi^*)$, then the claim follows by induction for T_{j+1}^{2i-1} and T_{j+1}^{2i} , because $\phi_{T_j^i}(\pi^*, \pi) = \phi_{A_j^i}(\pi^*, \pi) + \phi_{T_{j+1}^{2i-1}}(\pi^*, \pi) + \phi_{T_{j+1}^{2i}}(\pi^*, \pi) \geq 1 + 1 + 1 = 3$.

It remains the case that $\pi(x) \neq \pi^*(x)$ for $x \in \{\alpha_j^i, \gamma_j^i\}$ while $\pi(a_j^i) = \pi^*(a_j^i)$. If $\pi(\alpha_j^i) \neq \pi^*(\alpha_j^i)$, then $\phi_{A_j^i}(\pi, \pi^*) \geq 2$. If $\pi(\gamma_j^i) \neq \pi^*(\gamma_j^i)$, then $\phi_{A_j^i}(\pi, \pi^*) \geq 2$ or $\phi_{A_j^i}(\pi, \pi^*) \geq 0 \wedge \pi(\delta_j^i) = \{\delta_j^i, \alpha_{j+1}^{2i-1}, \alpha_{j+1}^{2i}\}$ and the claim follows by induction. \square

In the next lemma, we prove that the preferences used in the construction are even globally ranked.

When defining global rankings we will often connect rankings over subsets of coalitions with each other. To simplify the exposition, we introduce the notion of the *join* of two preference relations \succeq_1 and \succeq_2 over two disjoint sets C_1 and C_2 , respectively, as the preference relation $join(\succeq_1, \succeq_2) = \succeq_1 \cup \succeq_2 \cup C_1 \times C_2$ over the set $C_1 \cup C_2$. In other words, two sets $X, Y \in C_1, C_2$ are in relation $join(\succeq_1, \succeq_2)$ if $X, Y \in C_i$ and $X \succeq_i Y$ for some $i \in [2]$, or if $X \in C_1$ and $Y \in C_2$. We extend this definition recursively to the join of relations $\succeq_1, \dots, \succeq_k$ over pairwise disjoint sets C_1, \dots, C_k as $join(C_1, \dots, C_k) = join(join(C_1, \dots, C_{k-1}), C_k)$ for $k \geq 3$. Note that the join operation is not commutative.

Lemma 4. *Let an instance (R, S) of $X3C$ be given and define the corresponding flatmate game as above. Then, the preferences are globally ranked.*

Proof. The global preferences are composed of preferences \succ_0, \dots, \succ_k over the sets of coalitions C_0, \dots, C_k , where C_j is essentially the set of coalitions that is individually rational for some agent in A_j^i for some $i \in [2^j]$. More formally, $C_k = \bigcup_{i=1}^{2^k} \{C \subseteq N : \exists v \in A_k^i : C \succeq_v \{v\}\}$ and, for $j = k-1, \dots, 0$, $C_j = \bigcup_{i=1}^{2^j} \{C \subseteq N : \exists v \in A_j^i : C \succeq_v \{v\}\} \setminus C_{j+1}$. Note that this separates coalitions by level, and $C_j \cap C_{j'} = \emptyset$ for $j \neq j'$. In particular, coalitions of the types $\{\delta_j^i, \alpha_{j+1}^{2i-1}, \alpha_{j+1}^{2i}\}$, $\{\delta_{k-1}^i, a_k^{2i-1}, a_k^{2i}\}$, and $\{b_j^i, c_{j+1}^{2i-1}, c_{j+1}^{2i}\}$ that involve agents of two levels are added to the coalitions of the higher level. The global ranking is given in succinct form over $\bigcup_{j=0}^k C_j$ as $join(\succ_0, \dots, \succ_k)$. It can be extended to a full global ranking by adding coalitions that are not individually rational for one of its members at the bottom. It remains to specify these subrankings. The preferences over sets of coalitions can always be arbitrary. The ranking \succ_k is given as

$$\begin{aligned} & \{\{y_1^i, y_2^i\} : i \in [|R| + 1, 2^k]\}^\succ \\ & \succ_k \{\{b_k^i, y_2^i\} : i \in [|R| + 1, 2^k]\}^\succ \\ & \succ_k \{\{y_1^i\}, \{y_2^i\} : i \in [|R| + 1, 2^k]\}^\succ \\ & \succ_k \{\{b_k^i, b_k^v, b_k^w\} : \{r^i, r^v, r^w\} \in S \text{ for some } v, w \in [|R|]\}^\succ \\ & \succ_k \{\{b_k^i\} : i \in [2^k]\}^\succ \\ & \succ_k \{\{a_k^i, b_k^i, c_k^i\} : i \in [2^k]\}^\succ \\ & \succ_k \{\{b_{k-1}^i, c_k^{2i-1}, c_k^{2i}\}, \{\delta_{k-1}^i, a_k^{2i-1}, a_k^{2i}\} : i \in [2^{k-1}]\}^\succ \\ & \succ_k \{\{a_k^i\}, \{c_k^i\} : i \in [2^k]\}^\succ \end{aligned}$$

For $j \in [k-1]$, the ranking \succ_j is given as

$$\begin{aligned} & \{\{\gamma_j^i, \delta_j^i\} : i \in [2^j]\}^\succ \\ & \succ_j \{\{a_j^i, \beta_j^i, \gamma_j^i\} : i \in [2^j]\}^\succ \\ & \succ_j \{\{a_j^i, b_j^i, c_j^i\}, \{\alpha_j^i, \beta_j^i\} : i \in [2^j]\}^\succ \\ & \succ_j \{\{b_{j-1}^i, c_j^{2i-1}, c_j^{2i}\}, \{\delta_{j-1}^i, \alpha_j^{2i-1}, \alpha_j^{2i}\} : i \in [2^{j-1}]\}^\succ \\ & \succ_j \{\{a_j^i\}, \{b_j^i\}, \{c_j^i\}, \{\alpha_j^i\}, \{\beta_j^i\}, \{\gamma_j^i\}, \{\delta_j^i\} : i \in [2^j]\}^\succ \end{aligned}$$

Finally, \succ_0 is given as

$$\begin{aligned} & \{\{\gamma_0^1, \delta_0^1\} \succ_0 \{a_0^1, \beta_0^1, \gamma_0^1\} \succ_0 \{a_0^1, b_0^1, c_0^1\}, \{\alpha_0^1, \beta_0^1\}\}^\succ \\ & \succ_0 \{\{a_0^1\}, \{b_0^1\}, \{c_0^1\}, \{\alpha_0^1\}, \{\beta_0^1\}, \{\gamma_0^1\}, \{\delta_0^1\}\}^\succ \end{aligned}$$

The individual preferences are clearly induced by the global ranking. \square

In order to prove Theorem 3, we prove each statement individually. We start with the existence of strongly popular partitions and computation of mixed popular partitions, because they only need one copy of the auxiliary graph obtained through instances of X3C. The reduction for popularity relies on a certain instance of a flatmate game without popular partition that is introduced in Proposition 8. Several agents in this instance are now replaced by the generic gadget.

For an overview, we split the proof into the following individual statements:

- Theorem 10: Existence of strongly popular partitions,
- Theorem 11: Computation of mixed popular partitions,
- Theorem 12: Existence of popular partitions,
- Theorem 13: Verification of popular partitions, and
- Theorem 14: Verification of strongly popular partitions.

We are now ready to apply the two lemmas for the desired reductions.

Theorem 10. *Deciding whether there exists a strongly popular partition in flatmate games is coNP-hard, even if preferences are strict and globally ranked.*

Proof. The reduction is from X3C. Given an instance (R, S) of X3C, we define a hedonic game on agent set $N' = N \cup \{z\}$ where the agents N are as in the above construction with the identical preferences except changing the preferences of c_0^1 to $\{a_0^1, b_0^1, c_0^1\} \succ_{c_0^1} \{c_0^1, z\} \succ_{c_0^1} \{c_0^1\}$, and $\{c_0^1, z\} \succ_z \{z\}$. In particular, for every agent in $N \setminus \{c_0^1\}$, partitions together with z are not individually rational. Note that $|N'| = 3 \sum_{j=0}^k 2^j + 4 \sum_{j=0}^{k-1} 2^j + 2(2^k - |R| - 1) + 1 = 12 \cdot 2^k - 2 \cdot |R| - 8 = \mathcal{O}(|R|)$ and the reduction is in polynomial time.

Consider the partition $\sigma^* = \{\{a_j^i, b_j^i, c_j^i\}: j \in [0, k], i \in [2^j]\} \cup \{\{\alpha_j^i, \beta_j^i, \gamma_j^i, \delta_j^i\}: j \in [0, k-1], i \in [2^j]\} \cup \{\{y_1^i, y_2^i\}: i \in [|R|+1, 2^k]\} \cup \{z\} = \pi^* \cup \{z\}$ for the partition π^* from Lemma 3. Let $\sigma \neq \sigma^*$ be given and define $\pi = (\sigma \setminus \sigma(z)) \cup \{\sigma(z) \setminus \{z\}\}$, i.e. the partition on the agent set N , where z left her coalition. Note that due to the preferences of agents in N , $\phi(\pi^*, \pi) \leq \phi_N(\sigma^*, \sigma)$. We investigate the popularity margin of σ^* and σ by a case distinction over the possible coalitions for agent z using the knowledge of Lemma 3 about the relationship of the partitions π^* and π . If $\sigma(z) = \{z\}$, then $\phi(\sigma^*, \sigma) = \phi(\pi^*, \pi) \geq 1$. If $\sigma(z) = \{x, z\}$, then $\phi(\sigma^*, \sigma) \geq -1 + \phi(\pi^*, \pi) \geq -1 + 1 \geq 0$. Otherwise, $\phi(\sigma^*, \sigma) = 1 + \phi(\pi^*, \pi) \geq 1$. It follows directly that σ^* is popular and hence there exists a strongly popular partition if and only if σ^* is strongly popular. We will prove that this is the case if and only if the instance of X3C is a ‘no’-instance.

Assume that there exists no 3-partition of R through sets in S . The only case above, where the popularity margin is not strictly positive, is if $\sigma(z) = \{z, x\}$, but in this case $\pi(x) = \{x\}$ and it follows that $\phi(\sigma^*, \sigma) \geq -1 + \phi(\pi^*, \pi) \geq -1 + 3 \geq 2$. Hence, σ^* is strongly popular.

Conversely, assume that there exists a 3-partition $S' \subseteq S$ of R . Define

$$\begin{aligned} \sigma' = & \{\{b_k^v, b_k^w, b_k^x\}: \{v, w, x\} \in S'\} \cup \{\{b_k^i, y_2^i\}, \{y_1^i\}: i \in [|R|+1, 2^k]\} \\ & \cup \{\{\delta_{k-1}^i, a_k^{2i-1}, a_k^{2i}\}: i \in [2^{k-1}]\} \cup \{\{b_j^i, c_{j+1}^{2i-1}, c_{j+1}^{2i}\}, \{a_j^i, \beta_j^i, \gamma_j^i\}: j \in [k-1], i \in [2^j]\} \\ & \cup \{\{\delta_j^i, \alpha_{j+1}^{2i-1}, \alpha_{j+1}^{2i}\}: j \in [k-2], i \in [2^j]\} \cup \{\{\alpha_0^1, \{z, c_0^1\}\}. \end{aligned}$$

It is easily checked that $\phi(\sigma', \sigma^*) = 0$.

Indeed, $N(\sigma', \sigma^*) = \{b_k^i: i \in [2^k]\} \cup \{\beta_j^i, \delta_j^i, a_j^i: j \in [0, k-1], i \in [2^j]\} \cup \{y_2^i: i \in [|R|+1, 2^k]\} \cup \{z\}$. Therefore, $|N(\sigma', \sigma^*)| = 2^k + 4 \sum_{j=1}^{k-1} 2^j + 2^k - (|R|+1) + 1 = 6 \cdot 2^k - |R| - 4 =$

$\frac{1}{2}|N'|$. Hence, $\phi(\sigma', \sigma^*) \geq 0$ and equality follows from popularity of σ^* . Therefore, there exists no strongly popular partition. \square

A similar reduction as in Theorem 10 works also for mixed popularity. However, we need two auxiliary agents to control the switch between a strongly popular and non-popular partition.

Theorem 11. *Computing a mixed popular partition in flatmate games is NP-hard, even if preferences are strict and globally ranked.*

Proof. We provide a Turing reduction from X3C to the problem of finding a partition in the support of a mixed popular partition together with its probability in this mixed partition.

Given an instance X3C, we construct a very similar game as in the proof of Theorem 10. We have $N' = N \cup \{z_1, z_2\}$ where the agents N are as in the above construction with identical preferences, except for changing the preferences of agent c_0^1 to $\{a_0^1, b_0^1, c_0^1\} \succ_{c_0^1} \{c_0^1, z_1, z_2\} \succ_{c_0^1} \{c_0^1\}$, and $\{c_0^1, z_1, z_2\} \succ_{z_i} \{z_i\}$ for $i \in [2]$. By a case distinction similar to the one in the proof of Theorem 10 and using Lemma 3, it follows that the partition $\pi^* = \{\{a_j^i, b_j^i, c_j^i\} : j \in [0, k], i \in [2^j]\} \cup \{\{\alpha_j^i, \beta_j^i, \gamma_j^i, \delta_j^i\} : j \in [0, k], i \in [2^j] \text{ odd}\} \cup \{\{y_1^i, y_2^i\} : i \in [|R| + 1, 2^k]\} \cup \{\{z_1\}, \{z_2\}\}$ is strongly popular if there exists no 3-partition of R through sets in S . Therefore the unique mixed popular partition assigns probability 1 to π^* .

On the other hand, assume that there exist a 3-partition $S' \subseteq S$ of R . Define $\pi = \{\{b_k^v, b_k^w, b_k^x\} : \{v, w, x\} \in S'\} \cup \{\{b_k^i, y_2^i\}, \{y_1^i\} : i \in [|R| + 1, 2^k]\} \cup \{\{\delta_{k-1}^i, a_k^{2i-1}, a_k^{2i}\} : i \in [2^{k-1}]\} \cup \{\{b_j^i, c_{j+1}^{2i-1}, c_{j+1}^{2i}\}, \{a_j^i, \beta_j^i, \gamma_j^i\} : j \in [k-1], i \in [2^j]\} \cup \{\{\delta_j^i, \alpha_{j+1}^{2i-1}, \alpha_{j+1}^{2i}\} : j \in [k-2], i \in [2^j]\} \cup \{\{\alpha_0^1\}, \{z_1, z_2, c_0^1\}\}$. It is easily checked that $\phi(\pi, \pi^*) = 1$. Therefore, there exists no mixed popular partition that assigns probability 1 to π^* .

We can solve X3C by computing a partition π in the support of a mixed popular partition and checking its probability in case $\pi = \pi^*$. \square

Popular partitions are guaranteed to exist in roommate games with strict and globally ranked preferences (Abraham et al., 2008). We show by means of a counterexample that this is no longer the case when moving from roommate to flatmate games. This example game will serve as a crucial gadget to prove the hardness of computing popular partitions.

Proposition 8. *There exists a flatmate game with strict and globally ranked preferences which does not admit a popular partition.*

Proof. Consider $N = \{x_1, x_2, x_3\} \cup \{z_1^j, z_2^j : j \in [4]\}$, and preferences induced by the global ranking \succ given by $\{\{x_1, z_1^j, z_2^j\} : j \in [4]\} \succ \{\{x_2, z_1^j, z_2^j\} : j \in [4]\} \succ \{\{x_3, z_1^j, z_2^j\} : j \in [4]\} \succ \{\{x_i\} : i \in [3]\} \cup \{\{z_k^j\} : k \in [2], j \in [4]\}$. We claim that there exists no popular partition. By Proposition 2, we only need to consider Pareto optimal partitions. Let π be any Pareto optimal partition. Then π is individually rational. We will show how to obtain a more popular partition. By the pigeon hole principle, there exists $j \in [4]$ with $\{z_1^j\}, \{z_2^j\} \in \pi$. If there exists $i \in [3]$ with $\{x_i\} \in \pi$, then creating the coalition $\{x_i, z_1^j, z_2^j\}$ is more popular.

Otherwise, we may assume that for some $\{j_1, j_2, j_3\} \subseteq [4]$, $\pi(x_i) = \{x_i, z_1^{j_i}, z_2^{j_i}\}$, for $i \in [3]$. Let $j_4 \in [4] \setminus \{j_1, j_2, j_3\}$ be the remaining index. We obtain a new partition π' by forming $\pi'(x_i) = \{x_i, z_1^{j_i+1}, z_2^{j_i+1}\}$, leaving $z_1^{j_1}$ and $z_2^{j_1}$ in singleton coalitions.

Then, $N(\pi', \pi) \supseteq \{z_1^{j_i}, z_2^{j_i} : i \in [2, 4]\}$ while $N(\pi, \pi') \subseteq \{x_1, x_2, x_3, z_1^{j_1}, z_2^{j_1}\}$. Hence, $\phi(\pi', \pi) \geq 1$. \square

The idea is to replace the agents x_i of this example by the gadget of Lemma 3 to obtain a hardness result.

Theorem 12. *Deciding whether there exists a popular partition in flatmate games with strict and globally ranked preferences is coNP-hard.*

Proof. Given an instance (R, S) of X3C, we construct the flatmate game (N, \succeq) with strict and globally ranked preferences as follows. We take 3 copies (N_i, \succeq_i) of the game of Lemma 3, where \succeq_i are the strict and globally ranked preferences of Lemma 4. Denote the special partition and agent of the lemma by π_i^* and $x_i = c_{0i}^1$, respectively. Also, denote the set of coalitions ranked by \succeq_i with C_i' and define $C_i = C_i' \setminus \{\{x_i\}\}$. We set $N = N_1 \cup N_2 \cup N_3 \cup \{z_1^j, z_2^j : j \in [4]\}$. To define global preferences, we define preferences over $C_4 = \{\{x_i, z_1^j, z_2^j\} : i \in [3], j \in [4]\} \cup \{\{x_i\} : i \in [3]\} \cup \{\{z_k^j\} : k \in [2], j \in [4]\}$.

$$\begin{aligned} & \{\{x_1, z_1^j, z_2^j\} : j \in [4]\} \succ \\ & \succ_4 \{\{x_2, z_1^j, z_2^j\} : j \in [4]\} \succ \\ & \succ_4 \{\{x_3, z_1^j, z_2^j\} : j \in [4]\} \succ \\ & \succ_4 (\{\{x_i\} : i \in [3]\} \cup \{\{z_k^j\} : k \in [2], j \in [4]\}) \succ \end{aligned}$$

The global ranking is given over $\bigcup_{j=1}^4 C_j$ as $\succeq = \text{join}(\succeq_1, \succeq_2, \succeq_3, \succeq_4)$ in succinct form.

We claim that there exists a popular partition if and only if (R, S) is a ‘no’-instance of X3C.

If (R, S) is a ‘no’-instance, consider $\pi^* = \bigcup_{i=1}^3 \pi_i^* \cup \{\{z_k^j\} : k \in [2], j \in [4]\}$. Let π be any other partition. Let $I = \{i \in [3] : \pi^*(x_i) \neq \pi(x_i)\}$ and define $N' = N_1 \cup N_2 \cup N_3$ and $Z = \{z_1^j, z_2^j : j \in [4]\}$. We have $\phi_{N'}(\pi^*, \pi) \geq 3|I|$ (due to Lemma 3) while $\phi_Z(\pi, \pi^*) \leq 2|I|$. Hence, π^* is more popular than π if $|I| \geq 1$. In the case $|I| = 0$, it holds $\phi_{N'}(\pi, \pi^*) \leq 0$ while $\phi_Z(\pi, \pi^*) \leq 0$ and as $\pi \neq \pi^*$, one of the inequalities must be strict.

Now assume that (R, S) is a ‘yes’-instance of X3C and assume for contradiction that π is popular (and hence Pareto optimal). Then, for $i \in [3]$, $i \in I$. Indeed, if $i \notin I$, then π restricted to N_i must be π_i^* (otherwise, π_i^* is more popular). There exists $j \in [4]$ with $\pi(z_1^j) \neq \{x_1, z_1^j, z_2^j\}$ and by Pareto optimality $\{z_1^j, z_2^j\} \in \pi$. We obtain a more popular partition π' by replacing the coalitions of $N_i \cup \{z_1^j, z_2^j\}$ by the partition of the proof of Theorem 11 for the subgame (N_i, \succeq_i) .

It remains the case that $I = [3]$. We may assume that for some $\{j_1, j_2, j_3\} \subseteq [4]$, $\pi(x_i) = \{x_i, z_1^{j_i}, z_2^{j_i}\}$, for $i \in [3]$. Let $j_4 \in [4] \setminus \{j_1, j_2, j_3\}$ be the remaining index. We obtain a new partition π' by removing $z_1^{j_4}, z_2^{j_4}$ from their coalitions and forming $\pi'(x_i) = \{x_i, z_1^{j_{i+1}}, z_2^{j_{i+1}}\}$, leaving $z_1^{j_1}$ and $z_2^{j_1}$ in singleton coalitions.

Then, $N(\pi', \pi) \supseteq \{z_1^{j_i}, z_2^{j_i} : i \in [2, 4]\}$ while $N(\pi, \pi') \subseteq \{x_1, x_2, x_3, z_1^{j_1}, z_2^{j_1}\}$. Hence, $\phi(\pi', \pi) \geq 1$, a contradiction. \square

To conclude the section, we deal with the problem of verifying whether a given partition is popular or strongly popular. The respective results follow directly from the constructions of the hardness of existence.

Theorem 13. *Verifying whether a given partition in a flatmate game with strict and globally ranked preferences is popular is coNP-complete.*

Proof. In the proof of Theorem 12, the partition π^* is popular if and only if (R, S) is a ‘no’-instance of X3C. \square

Theorem 14. *Verifying whether a given partition in a flatmate game is strongly popular is coNP-complete, even if preferences are strict and globally ranked.*

Proof. In the proof of Theorem 10, the partition π^* is strongly popular if and only if (R, S) is a ‘no’-instance of X3C. \square

A.3 Cardinal hedonic games

In this section, we provide the missing proofs about our cardinal classes of hedonic games. We split the section into a part about additively separable and fractional hedonic games. The theorems of Section 4.3 are split into two respective theorems as listed in Table 2.

Problem	Theorem Body	Theorem ASHG	Theorem FHG
Existence PO (NP)	Theorem 4	Theorem 15	Theorem 21
Existence PO (coNP)	Theorem 9	Theorem 20	Theorem 26
Verification PO	Theorem 5	Theorem 16	Theorem 22
Auxiliary property R	Lemma 2	Lemma 5	Lemma 6
Existence sPOP	Theorem 6	Theorem 17	Theorem 23
Verification sPOP	Theorem 7	Theorem 18	Theorem 24
Computation mPOP	Theorem 8	Theorem 19	Theorem 25

Table 2: Overview of the theorems on cardinal classes of hedonic games. The theorems from the body of the paper are each split into to separate theorems as indicated by the table.

A.3.1 Additively separable hedonic games

We start by having a look at an example of an ASHG that contains no popular partition and that will be used as a gadget in the hardness construction. There are smaller ASHGs without a popular partition, but the instance of the proposition satisfies further properties required for the reduction of Theorem 15 to work. All games considered in this section only contain a single negative weight, whose absolute value is large enough to ensure that certain coalitions will not form.

Proposition 9. *Let $0 < \epsilon < 1$ and $K \geq 4$. Consider the following ASHG, depicted in Figure 2 with agent set $N = \{a_1, a_2, a_3, b_1, b_2, b_3, c_1, c_2\}$ and utilities given by $v(a_i, c_1) = 2, v(a_i, c_2) = 1, v(a_i, b_i) = \epsilon, v(b_i, c_2) = 0$ for all $i \in [3]$ and $v(x, y) = -K$ for all other values not defined, yet. Then, there exists no popular partition.*

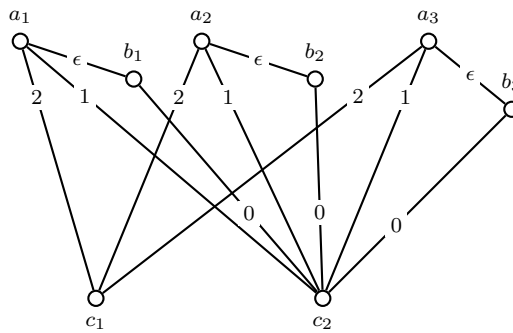

Figure 2: Instance of an additively separable hedonic game with no popular partition. Omitted edges have weight $-K$.

Proof. Assume for contradiction that π was a popular partition. Then the following facts hold:

- $a_i \notin \pi(a_j), i \neq j,$
- $a_i \notin \pi(b_j), i \neq j,$
- $b_i \notin \pi(b_j), i \neq j,$ and
- $c_1 \notin \pi(c_2), c_1 \notin \pi(b_j).$

In all of these cases, dissolving the coalition in question would be more popular, because all but possibly one agent in the coalition have negative utility and an agent with non-negative utility can only be contained in the coalition if it contains at least 3 agents. Note that K is larger than the sum of positive weights incident to any agent and therefore its utility is negative once it is in a coalition with an agent that gives negative utility.

Now, for every j , exactly one of the following holds: $c_1 \in \pi(a_j)$ or $b_j \in \pi(a_j)$. In fact, both cannot hold as excluded above. If none holds, then $\pi(a_j) \subseteq \{a_j, c_2\}$ and we could delete b_2 from its coalition (making no agent worse) and add it to $\pi(a_j)$, resulting in a more popular partition.

Next, for $i \in [2]$, there exists j with $c_i \in \pi(a_j)$. Otherwise, there existed k with $\pi(a_k) \subseteq \{a_k, b_k\}$ and removing b_k and adding c_i is more popular.

Thus, up to symmetry, the only possibility is $\pi = \{\{a_1, c_1\}, \{b_1\}, \{a_2, c_2, b_2\}, \{a_3, b_3\}\}$. But then $\{\{a_2, c_1\}, \{b_2\}, \{a_3, c_2, b_3\}, \{a_1, b_1\}\}$ is more popular. Hence, π was not popular. \square

We now discuss the proof strategy for showing that computing popular partitions in symmetric ASHG is NP-hard.

For a reduction from X3C, given an instance (R, S) , we have R -gadgets for every element of the ground set R and S -gadgets for every 3-elementary set in S . The gadgets for elements of R rely on the ASHG of Proposition 9. The gadget for a set $s \in S$ consists of three agents that are very happy in a coalition of their own, but one of them is linked to the R -gadgets corresponding to the agents in s and can simultaneously prevent the agents in these R -gadgets from voting down a partition. This is of course at the expense of the happiness of agents in the S -gadgets and can only happen if all three R -gadgets are simultaneously dealt with. This is where we achieve the correspondence of the covering with 3-partitions, which we can read off from the coalitions of the agents in S -gadgets.

Theorem 15. *Checking whether there exists a popular partition in a symmetric ASHG is NP-hard.*

Proof. The reduction is from X3C to deciding whether there exists a popular partition.

Let (R, S) be an instance of X3C. This can be reduced to an instance (N, \succ) , where (N, \succ) is an ASHG defined in the following way.

Let $N = \{a_1^r, a_2^r, a_3^r, b_1^r, b_2^r, b_3^r, c_1^r, c_2^r : r \in R\} \cup \{y^s, z_1^s, z_2^s : s \in S\}$ and edge weights as

- $v(a_i^r, c_1^r) = 2$ and $v(a_i^r, c_2^r) = 1, v(a_i^r, b_i^r) = \epsilon, v(b_i^r, c_2^r) = 0$ for all $i \in [3]$ and $r \in R,$
- $v(a_3^r, a_3^{r'}) = 0, v(b_3^r, a_3^{r'}) = 0, v(b_3^r, b_3^{r'}) = 0$ for all $s \in S$ and $r, r' \in s,$
- $v(a_3^r, y^s) = 5$ and $v(b_3^r, y^s) = 0$ for all $s \in S$ and $r \in R$ such that $r \in s,$
- $v(y^s, z_1^s) = v(y^s, z_2^s) = 10$ and $v(z_1^s, z_2^s) = 0$ for all $s \in S,$ and
- $v(x, y) = -40$ for all other valuations not defined.

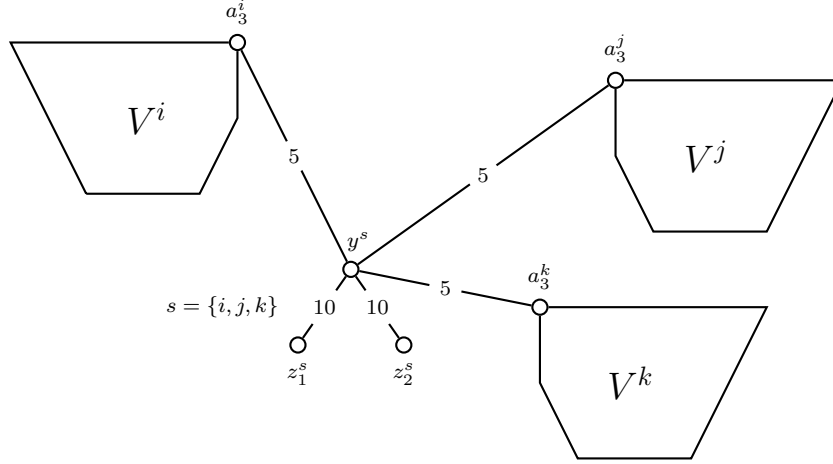

Figure 3: Schematic of the reduction of the existence problem for ASHG. Edges of weight 0 and of negative weight are omitted.

In order to enable the reduction, we can, for example, choose $\epsilon = \frac{1}{2}$.

A schematic of the reduction for a certain set $s = \{i, j, k\} \in S$ is depicted in Figure 3. We abbreviate in the figure and the rest of the proof $V^r = \{a_1^r, a_2^r, a_3^r, b_1^r, b_2^r, b_3^r, c_1^r, c_2^r\}$, where $r \in R$, and $W^s = \{y^s, z_1^s, z_2^s\}$, where $s \in S$. Also denote $V^R = \cup_{r \in R} V^r$, $W^S = \cup_{s \in S} W^s$ and $A_3 = \{a_3^r : r \in R\}$.

We show that there exists a popular partition of (N, \succsim) if and only if (R, S) is a ‘yes’ instance of X3C.

Assume (R, S) is a ‘yes’ instance of X3C. Then, there exists $S' \subseteq S$ such that S' is a partition of R . The following partition π is then popular: $\{\{a_1^r, c_1^r\} : r \in R\} \cup \{\{a_2^r, b_2^r, c_2^r\} : r \in R\} \cup \{\{y^s, a_3^i, a_3^j, a_3^k, b_3^i, b_3^j, b_3^k\} : s = \{i, j, k\} \in S'\} \cup \{W^s : s \in N \setminus S'\} \cup \{\{z_1^s, z_2^s\} : s \in S'\}$.

Assume for contradiction that π' is more popular than π .

We first prove the following two claims:

1. Let $r \in R$ such that for all $s \in S$ with $r \in s$ holds that $y^s \notin \pi'(a_3^r)$. Then, $|N(\pi, \pi') \cap V^r| - |N(\pi', \pi) \cap V^r| \geq 1$.
2. Let $r \in R$. If $|\{y^s : s \in S\} \cap \pi'(a_3^r)| \leq 1$ then, $|N(\pi, \pi') \cap V^r| - |N(\pi', \pi) \cap V^r| \geq 0$. If $|\{y^s : s \in S\} \cap \pi'(a_3^r)| \geq 2$ then, $|N(\pi, \pi') \cap V^r| - |N(\pi', \pi) \cap V^r| \geq -1$.

We start with the proof of the first claim.

Let therefore $r \in R$ such that for all $s \in S$ with $r \in s$ holds that $y^s \notin \pi'(a_3^r)$. Since $r \in R$ is fixed, we omit the superscript r for proving this claim. We know that $a_3 \in N(\pi, \pi')$ and $b_2, b_3 \notin N(\pi', \pi)$. We distinguish several cases:

- First, consider the case that $c_1 \in \pi'(a_1)$. Then, $b_1, a_2 \notin N(\pi', \pi)$. In addition, we may assume $a_1 \notin N(\pi', \pi)$, because otherwise $c_1, c_2 \in N(\pi, \pi')$ and the claim is true.

If $c_i \in N(\pi', \pi)$, then $c_{3-i} \notin N(\pi', \pi)$ and either $(a_1 \in N(\pi, \pi') \vee a_2 \in N(\pi, \pi')) \wedge b_3 \in N(\pi, \pi')$ or $a_1, a_2 \in N(\pi, \pi')$. In every case, $|N(\pi', \pi)| \leq 2$ and $|N(\pi, \pi')| \geq 3$ and the claim follows.

Hence, we may assume that $c_i \notin N(\pi', \pi)$ and no agent can be in $N(\pi', \pi)$. In this case, the claim follows.

- Second, assume $c_1 \in \pi'(a_2)$. Then, $a_1, b_2 \in N(\pi, \pi')$. If $a_2 \notin N(\pi', \pi)$, then it has a negative neighbor, i.e., $a_2 \in N(\pi, \pi')$. We have $|N(\pi, \pi')| \geq 4, |N(\pi', \pi)| \leq 3$.
Hence, $a_2 \in N(\pi', \pi)$. As a consequence, $c_1 \notin N(\pi', \pi)$ and $c_2 \notin N(\pi', \pi) \vee b_1 \notin N(\pi', \pi)$ and we conclude with $|N(\pi, \pi')| \geq 3, |N(\pi', \pi)| \leq 2$.
- Third, assume $c_1 \in \pi'(a_3)$. Then, $a_1, b_3 \in N(\pi, \pi')$. If $c_2 \in \pi'(a_3)$, then $c_1, c_2, a_2 \in N(\pi, \pi')$ and we conclude with $|N(\pi, \pi')| \geq 6$. If $c_2 \notin \pi'(a_3)$, then $\{a_1, a_3, b_3\} \subseteq N(\pi, \pi')$ and $a_2, b_2 \notin N(\pi', \pi)$ and either $b_2 \in N(\pi, \pi')$ or $c_2 \notin N(\pi', \pi)$.
- Finally, assume $c_1 \notin \pi'(a_1) \cup \pi'(a_2) \cup \pi'(a_3)$. Then $a_1, c_1 \in N(\pi, \pi')$ and $a_2 \notin N(\pi', \pi) \vee c_2 \notin N(\pi', \pi)$. Hence, $|N(\pi, \pi')| \geq 3, |N(\pi', \pi)| \leq 2$. This concludes the proof of the first claim.

Before we prove the second claim, we argue that we can assume without loss of generality that for all $r \in R$, $\pi'(a_3^r) \cap V^r \subseteq \{a_3^r, b_3^r\} \vee \{y^s : s \in S\} \cap \pi'(a_3^r) = \emptyset$. Indeed, if both conditions are not met, then leaving with $y^s \in \{y^s : s \in S\} \cap \pi'(a_3^r)$ and forming a coalition with W^s yields a partition π'' with the following properties:

- $|N(\pi'', \pi) \cap (N \setminus W^s)| \geq |N(\pi', \pi) \cap (N \setminus W^s)| - 1$ (Note that the only agent that is not still better off is possibly a_3^r since the other $a_3^{r'}$ are worse off since they would get negative utility in $\pi'(a_3^r)$.),
- $|N(\pi, \pi'') \cap (N \setminus W^s)| \geq |N(\pi, \pi') \cap (N \setminus W^s)| + 1$ (the only candidate is again a_3^r),
- $|N(\pi'', \pi) \cap W^s| \geq |N(\pi', \pi) \cap W^s| + 3$ if $\pi(y^s) \neq W^s$, and
- $|N(\pi, \pi'') \cap W^s| \geq |N(\pi, \pi') \cap W^s| - 3$ if $\pi(y^s) = W^s$.

Other changes in W^s cannot occur at the same time and we conclude $\phi(\pi'', \pi) \geq \phi(\pi', \pi)$ (in fact the inequality is strict).

For the second claim, this means that if some $y^s \in \pi'(a_3^r)$ we can consider π' modified such that y^s leaves its coalition. This can only decrease the size of $N(\pi', \pi) \cap V^r$ if $|\{y^s : s \in S\} \cap \pi'(a_3^r)| \geq 2$ and cannot increase the size of $N(\pi, \pi') \cap V^r$ by more than 1. Hence, the claim follows from the first case.

We define the set of critical subsets $s \in S$ as $Y^c = \{s \in S : \exists r \in R \text{ with } y^s \in \pi'(a_3^r)\}$ and the set of happy R gadgets as $R^h = \{r \in R : |\{y^s : s \in S\} \cap \pi'(a_3^r)| \geq 2\}$.

We know that for every $y^s \in Y^c$ at most 3 of the a_3^r do not satisfy the condition of the first claim. Hence, a total of $\max\{|R| - 3|Y^c| + |R^h|, 0\}$ of the agents a_3^r does so. Putting together the claims yields

$$\begin{aligned} & |N(\pi, \pi') \cap V^R| - |N(\pi', \pi) \cap V^R| \\ & \geq \max\{|R| - 3|Y^c| + |R^h|, 0\} - |R^h| \geq |R| - 3|Y^c|. \end{aligned} \tag{1}$$

We claim that in addition

$$|N(\pi', \pi) \cap W^S| - |N(\pi, \pi') \cap W^S| \leq |R| - 3|Y^c|. \tag{2}$$

The idea to prove this inequality is that every agent y^s has to decide whether the agents in W^s or the a_3^r with $r \in s$ should be happy. Without loss of generality, we can assume that for all $s \in S$, $\pi(y^s) \cap A_3 = \emptyset$ or $\pi(y^s) \cap W^s = \{y^s\}$. Indeed, if both conditions are not met, then leaving with y^s and forming a coalition with W^s yields a partition π'' with $\phi(\pi'', \pi) \geq \phi(\pi', \pi)$.

To prove Equation (2) note that $W^s \subseteq N(\pi, \pi') \cap W^S$ for every $s \in Y^c$ such that $\pi(y^s) = W^s$. In other words, $|N(\pi, \pi') \cap W^S| \geq 3|\{s \in Y^c : \pi(y^s) = W^s\}|$.

In addition, the only agents that get better in W^S can be in a W^s such that $\pi(y^s) \neq W^s$ and $y^s \notin Y^c$. This is, $|N(\pi', \pi) \cap W^S| \leq 3|\{s \notin Y^c: \pi(y^s) \neq W^s\}|$.

Combining the inequalities yields

$$\begin{aligned} & |N(\pi', \pi) \cap W^S| - |N(\pi, \pi') \cap W^S| \\ & \leq 3(|\{s \notin Y^c: \pi(y^s) \neq W^s\}| - |\{s \in Y^c: \pi(y^s) = W^s\}|) \\ & = 3(|\{s \notin Y^c: \pi(y^s) \neq W^s\}| + |\{s \in Y^c: \pi(y^s) \neq W^s\}| \\ & \quad - |\{s \in Y^c: \pi(y^s) = W^s\}| - |\{s \in Y^c: \pi(y^s) = W^s\}|) \\ & = 3|S'| - 3|Y^c| = |R| - 3|Y^c|. \end{aligned}$$

Combining Equation (1) and Equation (2) yields $|N(\pi, \pi')| - |N(\pi', \pi)| \geq 0$, contradicting the assumption that π' was more popular than π .

It remains to prove that every popular partition yields a 3-partition of R with sets in S . Therefore, assume that π is a popular partition in (N, \succsim) . The partition will be found by checking intersections of $\pi(y^s) \cap A_3$ as captured in the following claims:

1. For all $r \in R$ there exists a unique $s \in S$ with $y^s \in \pi(a_3^r)$. For this s holds that $r \in s$.
2. For all $s \in S$ holds: $(\exists i \in s: a_3^i \in \pi(y^s)) \Rightarrow (\forall j \in s, a_3^j \in \pi(y^s))$.

If the claim is true, $S' = \{s \in S: A_3 \cap \pi(y^s) \neq \emptyset\}$ covers R due to existence and is a partition due to uniqueness and the second claim that ensures that either all three or none of the agents in A_3 corresponding to elements in s are present in a coalition $\pi(y^s)$.

We start to show the existence part of the first claim which will follow directly from the property that $N|_{V^r}$ contains no popular partition (Proposition 9).

Assume for contradiction that there exists a $r \in R$ such that for all $s \in S$ holds $y^s \notin \pi(a_3^r)$. We obtain a more popular partition in two steps. First, we modify π such that for all agents in $v \in V^r$ we split their coalition into $\pi(v) \cap V^r$ and $V^r \setminus \pi(v)$. This cannot decrease the utility of any agent. Application of Proposition 9 yields a more popular partition locally on V^r that can be extended to the whole N via the remaining (modified) coalitions in π .

For the uniqueness part assume for contradiction that there is $r \in R$ and $s \neq s' \in S$ with $\{y^s, y^{s'}\} \subseteq \pi(a_3^r)$. We distinguish two cases.

First, assume that $|\pi(a_3^r) \cap A_3| \leq 3$. Then, there exists (without loss of generality using symmetry amongst s and s') an agent $r' \in R$ with $r' \in s$ and $a_3^{r'} \notin \pi(a_3^r)$. Then, the partition π' obtained from π by removing the agents in W^s from their partitions in π and letting them form a coalition is more popular. Indeed, $|N(\pi, \pi')| \leq 2$ (the two remaining agents a_3^t with $t \neq r'$ and $t \in s$ are the only ones to possibly loose utility) and $W^s \subseteq N(\pi', \pi)$.

Second, assume that $|\pi(a_3^r) \cap A_3| \geq 4$. Then, there exists an agent $u \in A_3 \cap \pi(a_3^r)$ with $u \notin s$. The same partition π' as in the first case yields $|N(\pi, \pi')| \leq 3$ and $|N(\pi', \pi)| \geq |W^s \cup \{u\}| = 4$.

In both cases, we have found a more popular partition, a contradiction.

Finally, for the second claim, in the case that there exists a $s \in S$ with $1 \leq |\{j \in s: a_3^j \in \pi(y^s)\}| \leq 2$, the same rearrangement of coalitions (i.e., forming the coalition W^s) is more popular. \square

The verification problem for ASHG turns out to be coNP-complete. The proof of Theorem 16 is simpler than Aziz et al.'s (2013b) proof of a weaker statement for ASHG that do not have to be symmetric.

Theorem 16. *Checking whether a given partition in a symmetric ASHG is popular is coNP-complete.*

Proof. The problem is in coNP, because a more popular partition serves as a polynomial-time certificate for a ‘no’-instance.

For hardness, we reduce again from X3C. Given an instance (R, S) of X3C, we assume without loss of generality that $|R| \geq 6$. We define an ASHG (N, \succsim) given by $N = R \cup \{s_1, s_2, s_3: s \in S\} \cup \{b_1, b_2, b_3\}$ and weights as

- $v(i, s_3) = 1$ for $i \in s, s \in S$,
- $v(s_1, s_3) = v(s_2, s_3) = 4$ for $s \in S$,
- $v(s_j, b_j) = 1$ for $s \in S, j \in [2]$,
- $v(b_1, b_3) = v(b_2, b_3) = \alpha$ for $\frac{|R|}{3} - 1 < \alpha < \frac{|R|}{3}$,
- $v(i, j) = 0$ for $i, j \in R$, $v(s_1, s_2) = 0$ for $s \in S$, and $v(b_1, b_2) = 0$, and
- $v(x, y) = -\max\{12, |S| + |R|/3\}$ for all agents $x, y \in N$ such that no utility is defined, yet.

One can choose, e.g., $\alpha = (|R| - 1)/3$, but for the reduction, only the above bounds matter. We introduce some useful notation for the proof. Denote $V^s = \{s_1, s_2, s_3\}$ for $s \in S$, $B = \{b_1, b_2, b_3\}$, and $V = \cup_{s \in S} V^s$.

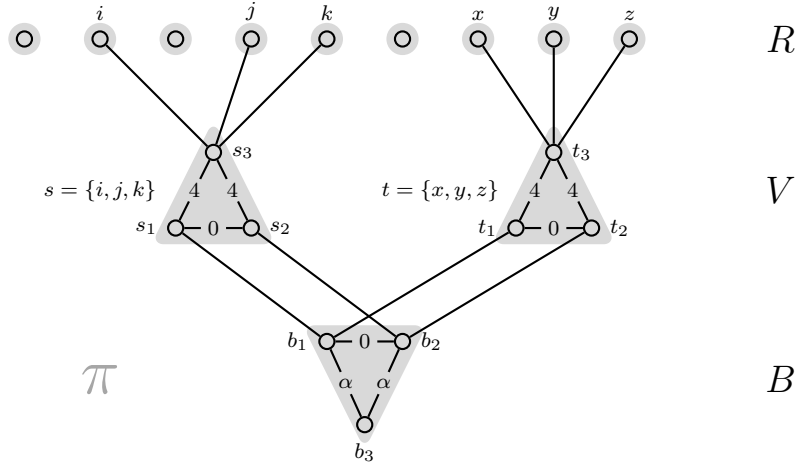

Figure 4: Schematic of the reduction for the verification problem of popular partitions on symmetric ASHG. Edges without explicit weight have weight 1. Omitted edges for agents in R have weight 0. All other omitted edges have weight -12 . The partition π marked in gray is the one under consideration for verification.

The partition in question is $\pi = \{V^s: s \in S\} \cup \{\{r\}: r \in R\} \cup \{B\}$. We claim that (R, S) is a ‘yes’-instance of X3C if and only if π is not popular for the ASHG given by G .

If (R, S) is a ‘yes’-instance, there exists a subset $S' \subseteq S$ that partitions R . In particular $|R| = 3|S'|$.

Consider the partition given by $\pi' = \{V^s: s \in S \setminus S'\} \cup \{\{s_3, i, j, k\}: \{i, j, k\} = s \in S'\} \cup \{\{b_j, s_j: s \in S'\}: j \in [2]\} \cup \{\{b_3\}\}$.

Then, $N(\pi', \pi) = R \cup \{b_1, b_2\}$ and $N(\pi, \pi') = \cup_{s \in S'} V^s \cup \{b_3\}$. Hence, π' is more popular than π .

Conversely, assume that there exists a more popular partition π' and fix one that maximizes $\phi(\pi', \pi)$. We have to prove that there exists a subset $S' \subseteq S$ that yields a partition

of R . Note that the negative weight is chosen so large that agents in a coalition linked by negative utility are always worse off.

First, we claim that for all $s \in S$, $N(\pi', \pi) \cap V^s = \emptyset$. Assume for contradiction that for $j \in [2]$, $s_j \in N(\pi', \pi)$. Then, $\{s_j, s_3, b_j\} \subseteq \pi'(s_j) \subseteq V^s \cup \{b_j\}$. Thus, $s_{3-j}, s_3, b_j, b_3 \in N(\pi, \pi')$.

We form a new coalition π'' from π' by having the coalitions V^s and B (these agents leave their coalitions in π') and all other coalitions remain the same. We consider two cases:

- If $|\pi'(b_{3-j}) \cap V| \leq 1$, then $b_{3-j} \in N(\pi, \pi')$. (We used that $|R| \geq 6$.) We have that $s_3, s_{3-j}, b_1, b_2, b_3 \in N(\pi, \pi') \setminus N(\pi, \pi'')$, $s_2 \in N(\pi', \pi) \setminus N(\pi, \pi'')$ and possibly the agent $t \in \pi'(b_{3-j}) \cap V$ yields $t \in N(\pi', \pi) \cap N(\pi, \pi'')$. Hence, $\phi(\pi'', \pi) > \phi(\pi', \pi)$.
- Otherwise, $\pi'(b_{3-j}) \cap V \subseteq N(\pi, \pi')$, but possibly $b_{3-j} \in N(\pi', \pi) \setminus N(\pi, \pi'')$ in addition. However, $\phi(\pi'', \pi) > \phi(\pi', \pi)$ remains valid.

In any case, we derived a contradiction to the maximality condition on π' .

If $s_3 \in N(\pi', \pi)$, then $\{s_1, s_2\} \subseteq \pi'(s_3)$, $s \cap \pi'(s_3) \neq \emptyset$, and $\pi'(s_3) \subseteq V^s \cup s$ (here $s \subseteq R$ is the set of R -agents corresponding to elements of the set s). Hence, forming a coalition π'' by leaving with the agents in s moves these agents and s_1, s_2 out of $N(\pi, \pi')$, while only removing s_3 from $N(\pi', \pi)$. Hence, we again contradict the maximality of $\phi(\pi', \pi)$.

For the rest of the analysis, we narrow down the possible more popular partitions to a very specific situation that corresponds to 3-partitions. The idea is basically that whenever we ‘sacrifice’ a set V^s of agents, we can improve only 3 agents in R . Due to the boundaries on α , we will cross the threshold, where we can have a popularity margin of precisely 1 exactly at the moment when we gathered $\frac{|R|}{3}$ neighbors for b_1 and b_2 in order to improve these.

We introduce the sets $R_I = R \cap N(\pi', \pi)$ and $S_C = \{s \in S : \pi'(s_3) \cap R \neq \emptyset\}$. Our goal is to prove $|R| = |R_I| = 3|S_C|$.

For $s \in S_C$ holds $V^s \subseteq N(\pi, \pi')$ (which follows for s_3 since $s_3 \notin N(\pi', \pi)$). Consequently, $|N(\pi, \pi') \cap V| \geq 3|S_C|$. In addition, $|N(\pi', \pi) \cap R| = |R_I| \leq 3|S_C|$ and $\phi_B(\pi', \pi) \leq 1$.

If $|R_I| < 3|S_C|$, then $\phi(\pi, \pi') = \phi_B(\pi, \pi') + \phi_V(\pi, \pi') + \phi_R(\pi, \pi') \geq -1 + 3|S_C| - (|R_I|) = 3|S_C| - |R_I| - 1 \geq 0$ and π' is not more popular. We conclude that $|R_I| = 3|S_C|$.

Before we conclude the proof, we show two auxiliary claims:

1. If $B \subseteq \pi'(b_3)$ then $b_1 \notin N(\pi', \pi) \vee b_2 \notin N(\pi', \pi)$.
2. For $j \in [2]$, if $b_j \in N(\pi', \pi)$, then $b_j \in \pi'(b_3) \vee |\{s \in S : s_j \in \pi'(b_j)\} \cap \pi'(b_j)| \geq \frac{|R|}{3}$.

The first claim follows from the fact that if b_j forms a coalition with an agent outside B that gives her positive utility, then b_{3-j} cannot be both in this coalition and improve her utility. The second claim follows from $Til_\pi(b_j) = \alpha > \frac{|R|}{3} - 1$.

We are ready to prove $|R| = 3|S_C|$. We consider the agents in B . The only possibility for $\phi(\pi', \pi) > 0$ is that $\phi_B(\pi', \pi) \geq 1$ which can only happen if $\{b_1, b_2\} \subseteq N(\pi', \pi)$. Due to the auxiliary claims, there exists $j \in \{1, 2\}$ with $|\{s \in S : s_j \in \pi'(b_j)\} \cap \pi'(b_j)| \geq \frac{|R|}{3}$.

If $s^* \in \{s \in S : s_j \in \pi'(b_j)\} \setminus S_C$, then $s_j^* \in N(\pi, \pi')$ (using $|R| \geq 6$, i.e., $|\pi'(b_j) \cap \{s \in S : s_j \in \pi'(b_j)\}| \geq 2$).⁷

Consequently, $\phi(\pi, \pi') = \phi_B(\pi, \pi') + \phi_V(\pi, \pi') + \phi_R(\pi, \pi') \geq -1 + (3|S_C| + 1) - 3|S_C| \geq 0$, a contradiction. Therefore, $\{s \in S : s_j \in \pi'(b_j)\} \subseteq S_C$ and $\frac{|R|}{3} \leq |\{s \in S : s_j \in \pi'(b_j)\}| \leq |S_C| = \frac{|R_I|}{3} \leq \frac{|R|}{3}$.

Consider the set $S' = S_C$. Then, S_C covers R since $R_I = R$. In addition, since $|R| = 3|S_C|$, every agent $r \in R$ is present in exactly one $s \in S_C$. Hence, S' is a partition of R with sets in S . In total, (R, S) is a ‘yes’-instance of X3C. \square

⁷This argument is stronger than what is needed for ASHG, but it is needed for the case of FHGs.

We first prove the existence of the graph that underlies the subsequent reductions for ASHG. It satisfies similar properties as the flatmate game considered in Lemma 3. However, for the reduction to work, we need two sets of auxiliary agents. The first set corresponds to the 3-elementary sets in S of an instance (R, S) of X3C, while the second set consists of two agents that allow the agents in the top-level not corresponding to elements of R to improve their coalition.

Lemma 5. *The class of symmetric ASHG satisfies property R.*

Proof. Let (R, S) be an instance of X3C. We construct the following game. Let $k = \min\{k \in \mathbb{N} : 2^k \geq |R|\}$ define the smallest power of 2 that is larger than the cardinality of R . We define an ASHG on vertex set $N = \{v_1^s, v_2^s : s \in S\} \cup \{y_1, y_2\} \cup \bigcup_{j=0}^k N_j$, where $N_j = \bigcup_{i=1}^{2^j} A_j^i$ consists of 2^j sets of agents A_j^i .

We define the sets of agents as

- $A_k^i = \{a_k^i, b_k^i, c_k^i\}$ for $i \in [2^k]$, and
- $A_j^i = \{a_j^i, b_j^i, c_j^i, \alpha_j^i, \beta_j^i, \gamma_j^i, \delta_j^i\}$ for $j \in [0, k-1], i \in [2^j]$.

We order the set R in an arbitrary but fixed way, say $R = \{r^1, \dots, r^{|R|}\}$ and for a better understanding of the proof and the preferences, we label the agents $b_k^i = r^i$ for $i \in [|R|]$. If we view the set of agents N as $k+1$ levels of agents, then the ground set R of the instance of X3C is identified with some specific agents in the top level k . We are ready to define the preferences as

- $v(v_1^s, v_2^s) = 6k + 8$ for all $s \in S$,
- $v(v_2^s, b_k^i) = 2k + 3$ if there exists $s \in S$ with $r^i \in s$,
- $v(y_1, y_2) = 1$,
- $v(y_2, b_k^i) = 2k + 3, i \in [|R| + 1, 2^k]$,
- $v(b_k^i, b_k^{i'}) = 0, i, i' \in [|R| + 1, 2^k]$,
- $v(b_k^i, b_k^{i'}) = 0, i, i' \in [|R|]$,
- $v(a_k^i, b_k^i) = v(a_k^i, c_k^i) = v(b_k^i, c_k^i) = k + 1, i \in [2^k]$,
- For $j \in [0, k-1], i \in [2^k]$,
 - $v(a_j^i, b_j^i) = v(a_j^i, c_j^i) = j + 1, v(b_j^i, c_j^i) = j + 1.5$,
 - $v(b_j^i, c_{j+1}^{2^i-1}) = v(b_j^i, c_{j+1}^{2^i}) = j + 1.5$,
 - $v(\alpha_j^i, \beta_j^i) = j + 1, v(\beta_j^i, \gamma_j^i) = 0$,
 - $v(\beta_j^i, a_j^i) = j + 1.75, v(\gamma_j^i, a_j^i) = j + 1.25$,
 - $v(\gamma_j^i, \delta_j^i) = j + 2, v(\delta_j^i, \alpha_{j+1}^{2^i-1}) = v(\delta_j^i, \alpha_{j+1}^{2^i}) = j + 1.5$, and
- $v(g, h) = -M - 1$ for all $g, h \in N$ such that the utility is not yet defined, where M is the maximum utility any agents could receive by the previous utilities.

Let $\pi^* = \{\{a_j^i, b_j^i, c_j^i\} : j \in [0, k], i \in [2^j]\} \cup \{\{\alpha_j^i, \beta_j^i\}, \{\gamma_j^i, \delta_j^i\} : j \in [0, k-1], i \in [2^j]\} \cup \{\{y_1, y_2\}\} \cup \{\{v_1^s, v_2^s\} : s \in S\}$ and $x = c_0^1$.

Now consider a partition $\pi \neq \pi^*$.

We will prove the following claim by induction over $j = k, \dots, 0$. For every $i \in [2^j]$ holds:

1. If $\{b_j^i, a_j^i\} \cap \pi(c_j^i) = \emptyset$, then $\phi_{T_j^i}(\pi^*, \pi) \geq 1$ and $\phi_{T_j^i}(\pi^*, \pi) \geq 3$ or $\{b_k^i : i \in [2^k]\} \cap T_j^i \subseteq N(\pi, \pi^*)$.
2. If $\alpha_j^i \notin N(\pi, \pi^*)$ and there exists an agent $z \in T_j^i$ with $\pi(z) \neq \pi^*(z)$. Then $\phi_{T_j^i}(\pi^*, \pi) \geq 1$.

We will start by arguing, how the first part of the lemma follows from the induction claim.

First, note that $y_1 \notin N(\pi, \pi^*)$ and if $y_2 \in N(\pi, \pi^*)$, then $y_1 \in N(\pi^*, \pi)$. Similarly, for all $s \in S$, $v_1^s \notin N(\pi, \pi^*)$ and if $v_2^s \in N(\pi, \pi^*)$, then $v_1^s \in N(\pi^*, \pi)$. We can therefore focus on T_0^1 and have $\phi(\pi^*, \pi) \geq \phi_{T_0^1}(\pi^*, \pi)$. Define $\rho = \{C \cap T_0^1 : C \in \pi\}$ and $\rho^* = \{C \cap T_0^1 : C \in \pi^*\}$, which are the partitions π and π^* restricted to agents in T_0^1 . If $\rho = \rho^*$, then $\pi \neq \pi^*$ can only happen if some agent outside T_0^1 forms a coalition with a former coalition of π^* in T_0^1 . Note that the only agents in T_0^1 that can improve by that are the agents of the type b_k^i . In every case, this will lead to $\phi_{T_0^1}(\pi^*, \pi) \geq 1$. As we have argued above, this implies $\phi(\pi^*, \pi) \geq 1$.

If $\rho \neq \rho^*$, we use the claim for the case $j = 0$ and observe that $\alpha_0^i \notin N(\pi, \pi^*)$. Hence, $\phi(\pi^*, \pi) \geq 1$ also holds in this case.

It needs still to be shown that if $\pi(x) \cap \pi^*(x) = \{x\}$, then $\phi(\pi^*, \pi) \geq 3$ or (R, S) is a ‘yes’-instance. Assume therefore that $\pi(x) \cap \pi^*(x) = \{x\}$. By the first part of the induction claim, we conclude that $\phi_{T_0^1}(\pi^*, \pi) \geq 3$ or $\{b_k^i : i \in [2^k]\} \subseteq N(\pi, \pi^*)$. Since we are done in the former case, we assume that $\{b_k^i : i \in [2^k]\} \subseteq N(\pi, \pi^*)$. This can only happen if, for every $i \in 1, \dots, |R|$, there exists an $s_i \in S$ with $v_2^{s_i} \in \pi(b_k^i)$. Define $S' = \{s \in S : \pi(s_2) \cap \{b_k^i : i \in [2^k]\} \neq \emptyset\}$. Now fix $s \in S'$. Then, it holds that $v_1^s \notin \pi(v_2^s)$, because otherwise agents $b_k^i \in \pi(v_1^s)$ are worse off than in π^* . In particular, $v_1^s \in N(\pi^*, \pi)$. Now, if at most two of the agents b_k^i corresponding two elements $i \in s$ are in the coalition of v_2^s , then $v_2^s \in N(\pi^*, \pi)$. Together, $\phi(\pi^*, \pi) \geq \phi_{\{y_1, y_2\}}(\pi^*, \pi) + \phi_{\{v_1^s, v_2^s\}}(\pi^*, \pi) + \sum_{s' \in S \setminus \{s\}} \phi_{\{v_1^{s'}, v_2^{s'}\}}(\pi^*, \pi) + \phi_{T_0^1}(\pi^*, \pi) \geq 0 + 2 + 0 + 1 = 3$. It remains the case that $\pi(v_2^s) = \{v_2^s, b_k^i, b_k^j, b_k^w\}$ for every $s \in S'$ with $s = \{i, j, w\}$. But then, S' is a 3-partition of R by sets in S .

We will now proceed with the proof of the induction claim.

For the base case $j = k$, we observe that if $A_k^i \cap N(\pi, \pi^*) \neq \emptyset$, then clearly $\phi_{A_k^i}(\pi^*, \pi) \geq 1$. In addition, if $\{b_k^i, a_k^i\} \cap \pi(c_k^i) = \emptyset$, then $\{a_k^i, c_k^i\} \subseteq N(\pi^*, \pi)$ and $b_k^i \in N(\pi^*, \pi) \cup N(\pi, \pi^*)$.

For the induction step, let $j \in \{k-1, \dots, 0\}$ and fix $i \in [2^j]$. Assume first that there exists an agent $z \in T_j^i$ with $\pi(z) \neq \pi^*(z)$ but no such agent in A_j^i . The premise of the first claim is vacuous and this part is therefore true. Since $z \in T_{j+1}^{2i-1} \vee z \in T_{j+1}^{2i}$, we can apply induction for the second claim since the premise of the second claim for T_{j+1}^{2i-1} or T_{j+1}^{2i} is true. Assume therefore that there exists an agent $z \in A_j^i$ with $\pi(z) \neq \pi^*(z)$.

We make the following observations.

- If $\alpha_j^i \in N(\pi, \pi^*)$, then $\beta_j^i \in N(\pi^*, \pi)$.
- If $\beta_j^i \in N(\pi, \pi^*)$, then $\alpha_j^i \in N(\pi^*, \pi)$.
- If $\gamma_j^i \in N(\pi, \pi^*)$, then $\delta_j^i \in N(\pi^*, \pi)$.
- If $\delta_j^i \in N(\pi, \pi^*)$, then $\gamma_j^i \in N(\pi^*, \pi)$.

Now, we consider the case that $\pi(a_j^i) \neq \pi^*(a_j^i)$.

- We consider first the subcase that $b_j^i \in N(\pi, \pi^*)$. Then $c_j^i \in N(\pi^*, \pi)$.

- If $\pi(b_j^i) \supseteq \{c_{j+1}^{2i-1}, c_{j+1}^{2i}\}$, then $\phi_{A_j^i}(\pi, \pi^*) \leq 1$ (with the above observations), while by induction $\phi_{T_{j+1}^{2i-1} \cup T_{j+1}^{2i}}(\pi^*, \pi) \geq 2$ and $\phi_{T_{j+1}^{2i-1} \cup T_{j+1}^{2i}}(\pi^*, \pi) \geq 4 \vee \{b_k^i : i \in [2^k]\} \cap (T_{j+1}^{2i-1} \cup T_{j+1}^{2i}) \subseteq N(\pi, \pi^*)$ and we are done.

- Otherwise, $c_j^i \in \pi(b_j^i)$. Then $\phi_{A_j^i}(\pi^*, \pi) \geq 1$ or $a_j^i \in N(\pi, \pi^*)$. The second case can only occur for $\pi(a_j^i) = \{a_j^i, \beta_j^i, \gamma_j^i\}$. Hence, $\phi_{A_j^i}(\pi^*, \pi) \geq 1$ or $\pi(\delta_j^i) = \{\delta_j^i, \alpha_{j+1}^{2i-1}, \alpha_{j+1}^{2i}\}$. But then $\phi_{A_j^i}(\pi^*, \pi) \geq -1$ and $\phi_{T_{j+1}^{2i-1} \cup T_{j+1}^{2i}}(\pi^*, \pi) \geq 2$ and we are done.
- We can even assume that $b_j^i \in N(\pi^*, \pi)$, since otherwise $a_j^i \in \pi(b_j^i)$ and $a_j^i, c_j^i \in N(\pi^*, \pi)$ and it follows $\phi_{A_j^i}(\pi^*, \pi) \geq 1$.
- If $c_j^i \in N(\pi, \pi^*)$, then $a_j^i, b_j^i \in N(\pi^*, \pi)$ and therefore $\phi_{A_j^i}(\pi^*, \pi) \geq 1$ and we are done.
- Since $\pi(c_j^i) \neq \pi^*(c_j^i)$, we can assume that $c_j^i \in N(\pi^*, \pi)$.
- Next, consider the case that $a_j^i \in N(\pi, \pi^*)$ and, by the previous cases, $c_j^i, b_j^i \in N(\pi^*, \pi)$.
 - If $\pi(a_j^i) = \{a_j^i, \beta_j^i, \gamma_j^i\}$, then $\phi_{A_j^i}(\pi^*, \pi) \geq 3$ or $\pi(\delta_j^i) = \{\delta_j^i, \alpha_{j+1}^{2i-1}, \alpha_{j+1}^{2i}\}$. In the latter case, $\phi_{A_j^i}(\pi^*, \pi) \geq 1$ and $\phi_{T_{j+1}^{2i-1} \cup T_{j+1}^{2i}}(\pi^*, \pi) \geq 2$ by induction and we are done.
 - Otherwise, $\beta_j^i \in \pi(a_j^i) \cap N(\pi^*, \pi)$ or $\gamma_j^i \in \pi(a_j^i) \cap N(\pi^*, \pi)$. In the former case, $\alpha_j^i \in N(\pi^*, \pi)$ and in total $\phi_{A_j^i}(\pi^*, \pi) \geq 3$. In the latter case, again, $\phi_{A_j^i}(\pi^*, \pi) \geq 3$ or $\pi(\delta_j^i) = \{\delta_j^i, \alpha_{j+1}^{2i-1}, \alpha_{j+1}^{2i}\}$ and the case is similar as before.
- It remains that $a_j^i, b_j^i, c_j^i \in N(\pi^*, \pi)$ in which case $\phi_{A_j^i}(\pi^*, \pi) \geq 3$.

We may therefore assume that $\pi(a_j^i) = \pi^*(a_j^i)$. Only for the remaining cases, we need that $\alpha_j^i \notin N(\pi, \pi^*)$. If $\pi(\alpha_j^i) \neq \pi^*(\alpha_j^i)$, then $\alpha_j^i, \beta_j^i \in N(\pi^*, \pi)$ and consequently $\phi_{A_j^i}(\pi^*, \pi) \geq 2$. If $\pi(\gamma_j^i) \neq \pi^*(\gamma_j^i)$, then $\phi_{A_j^i}(\pi^*, \pi) \geq 2$ or $\phi_{A_j^i}(\pi, \pi^*) \geq 0 \wedge \pi(\delta_j^i) \cap \{\alpha_{j+1}^{2i-1}, \alpha_{j+1}^{2i}\} \neq \emptyset$ and the claim follows by induction.

For the second part of the lemma, assume that S' is a 3-partition of R through sets in S . Define

$$\begin{aligned} \pi' = & \{ \{b_k^v, b_k^w, b_k^x, v_2^s\}, \{v_1^s\} : \{v, w, x\} = s \in S' \} \cup \{ \{v_1^s, v_2^s\} : s \in S \setminus S' \} \\ & \cup \{ \{b_k^{|R|+1}, \dots, b_k^{2^k}, y_2\}, \{y_1\} \} \cup \{ \{\delta_{k-1}^i, a_k^{2i-1}, a_k^{2i}\} : i \in [2^{k-1}] \} \\ & \cup \{ \{b_j^i, c_{j+1}^{2i-1}, c_{j+1}^{2i}\}, \{a_j^i, \beta_j^i, \gamma_j^i\} : j \in [k-1], i \in [2^j] \} \\ & \cup \{ \{\delta_j^i, \alpha_{j+1}^{2i-1}, \alpha_{j+1}^{2i}\} : j \in [k-2], i \in [2^j] \} \cup \{ \{\alpha_0^1\}, \{c_0^1\} \}. \end{aligned}$$

It is easily checked that $\phi(\pi', \pi^*) = 1$ and c_0^1 forms a singleton coalition with $c_0^1 \in N(\pi^*, \pi')$. \square

Theorem 17. *Checking whether there exists a strongly popular partition in a symmetric ASHG is coNP-hard.*

Proof. The reduction is from X3C. Given an instance (R, S) of X3C, we consider the symmetric ASHG of Lemma 5 on agent set N with utility function v together with the partition π^* and the special agent $x \in N$. Set $M = \max\{\sum_{w \in N: v(y,w) > 0} v(y, w) : y \in N\}$ and $\alpha = \min_{w \in N: v(x,w) > 0} v(x, w) > 0$. We define a symmetric ASHG on agent set $N' = N \cup \{z\}$ where the utilities are given by $v'(y, w) = v(y, w)$ if $y, w \in N$, $v'(z, x) = \alpha/2$, and $v'(z, y) = -M - 1$ for $y \in N \setminus \{x\}$. Note that by Lemma 5, this reduction is in polynomial time.

Consider the partition $\sigma^* = \pi^* \cup \{\{z\}\}$ and let $\sigma \neq \sigma^*$ be given and define $\pi = (\sigma \setminus \sigma(z)) \cup \{\sigma(z) \setminus \{z\}\}$, that is, the partition of agent set N where z leaves her coalition. We argue first that $\phi_N(\sigma^*, \sigma) \geq \phi(\pi^*, \pi)$ unless $\pi(x) = \pi^*(x)$. Clearly, if z leaves a coalition, only the agent x can be worse. Now recall that x receives her unique top-ranked coalition in π^* , which means that x forms a coalition precisely with all agents that yield her positive utility. By the choice of $v(x, z)$, the only coalition of x that z is part of and that is not worse for x , is $\pi^*(x) \cup \{z\}$. Hence, the only case that the preferences of x over σ^* and σ is affected by z is if $\pi(x) = \pi^*(x)$.

We perform a case distinction over the coalitions of z to investigate the popularity margin between σ^* and σ . First, if $\sigma(z) = \{z\}$, then $\phi(\sigma^*, \sigma) > 0$ by Lemma 5. If $\sigma(z) = \{z, x\}$, then $\phi(\sigma^*, \sigma) \geq -1 + \phi(\pi^*, \pi) \geq 0$. There, we can use the lemma again to see that the latter inequality is strict if (R, S) is a ‘no’-instance. Otherwise, $z \in N(\sigma^*, \sigma)$. If $\pi(x) \neq \pi^*(x)$, then $\phi(\sigma^*, \sigma) \geq 1 + \phi(\pi^*, \pi) \geq 1$. We can therefore assume that $\pi(x) = \pi^*(x)$. If $\pi = \pi^*$, then $\phi(\sigma^*, \sigma) = \phi_{\sigma^*(z)}(\sigma^*, \sigma) > 0$. If $\pi \neq \pi^*$, then $\phi(\sigma^*, \sigma) \geq 1 - 1 + \phi(\pi^*, \pi) > 0$, where the -1 accounts for the case that x may be worse off in π compared to σ . Note that it can not be the case that x is both better off in σ and worse off in π , since the only relevant coalition $\sigma(x) = \pi^*(x) \cup \{z\}$. Together, it follows that σ^* is popular and it is a strongly popular partition if (R, S) is a ‘no’-instance.

If (R, S) is a ‘yes’-instance, then σ^* is the only candidate that might be strongly popular. Consider the partition π' from Lemma 5 and define $\sigma' = (\pi' \setminus \{\{x\}\}) \cup \{\{x, z\}\}$. Then, $x \in N(\pi^*, \pi') \cap N(\sigma^*, \sigma')$, whereas $z \in N(\sigma', \sigma^*)$. Therefore, $\phi(\sigma', \sigma^*) = 1 + \phi(\pi', \pi^*) = 0$. Hence, π^* is not strongly popular and there exists no strongly popular partition. \square

Theorem 18. *Verifying whether a given partition in a symmetric ASHG is strongly popular is coNP-complete.*

Proof. In the proof of Theorem 17, the partition σ^* is strongly popular if, and only if, (R, S) is a ‘no’-instance of X3C. \square

Theorem 19. *Computing a mixed popular partition in a symmetric ASHG is NP-hard.*

Proof. We give a Turing reduction from X3C. Given an instance (R, S) of X3C, we consider the symmetric ASHG of Lemma 5 on agent set N with utility function v together with the partition π^* and the special agent $x \in N$. Set $M = \max\{\sum_{w \in N: v(y, w) > 0} v(y, w) : y \in N\}$ and $\alpha = \min_{w \in N: v(x, w) > 0} v(x, w) > 0$. We define a symmetric ASHG on agent set $N' = N \cup \{z_1, z_2\}$ where the utilities are given by $v'(y, w) = v(y, w)$ if $y, w \in N$, $v'(z_1, z_2) = v'(z_1, x) = v'(z_2, x) = \alpha/3 > 0$, and $v'(z_i, y) = -M - 1$ for $i \in [2], y \in N \setminus \{x\}$. Note that by Lemma 5, this reduction is in polynomial time.

Consider the partition $\sigma^* = \pi^* \cup \{\{z_1, z_2\}\}$ and let $\sigma \neq \sigma^*$ be given and define $\pi = (\sigma \setminus (\sigma(z_1) \cup \sigma(z_2))) \cup \{\sigma(z_1) \setminus \{z_1, z_2\}, \sigma(z_2) \setminus \{z_1, z_2\}\}$, that is, the partition of agent set N where z_1 and z_2 leave their coalitions. Assume that (R, S) is a ‘no’-instance. We will prove that $\phi(\sigma^*, \sigma) > 0$, and therefore that σ^* is strongly popular. We may assume that $\sigma(z_1) = \{z_1, z_2\}$ or $x \in \sigma(z_i)$ for some i , because otherwise it is a Pareto improvement if z_1 and z_2 leave their coalitions and form a coalition of their own.

If $\sigma(z_1) = \{z_1, z_2\}$, then by Lemma 5, $\phi(\sigma^*, \sigma) = \phi(\pi^*, \pi) > 0$, because $\pi \neq \pi^*$. Otherwise, assume without loss of generality that $x \in \sigma(z_1)$. Since x receives her top-ranked coalition in π^* and the utility provided by agents z_i is sufficiently small, $\phi_N(\sigma^*, \sigma) - \phi(\pi^*, \pi) \geq -1$, where equality can only hold for $\pi^*(x) = \pi(x)$. Now, if $\pi(z_1) \subseteq \{x, z_1, z_2\}$, then $\phi(\sigma^*, \sigma) \geq -2 + \phi(\pi^*, \pi) \geq 1$. If there exists $y \in N \setminus \{x\}$ with $y \in \sigma(z_1)$, then $z_1, z_2 \in N(\sigma^*, \sigma)$ and it follows $\phi(\sigma^*, \sigma) \geq 2 - 1 + \phi(\pi^*, \pi) > 0$. In particular, the unique mixed popular partition consists of σ^* with probability 1.

Now assume that (R, S) is a ‘yes’-instance. Consider the partition π' from Lemma 5 and define $\sigma' = (\pi' \setminus \{\{x\}\}) \cup \{\{x, z_1, z_2\}\}$. Then, $x \in N(\pi^*, \pi') \cap N(\sigma^*, \sigma')$, whereas $z_1, z_2 \in N(\sigma', \sigma^*)$. Therefore, $\phi(\sigma', \sigma) = 2 + \phi(\pi', \pi^*) = 1$. Hence, the pure mixed partition $\{\sigma^*\}$ is not mixed popular.

We can solve X3C by computing a partition σ in the support of a mixed popular partition and checking its probability in case $\sigma = \sigma^*$. \square

Theorem 20. *Checking whether there exists a popular partition in a symmetric ASHG is coNP-hard.*

Proof. We provide a reduction from X3C. Given an instance (R, S) of X3C, we consider the symmetric ASHG of Lemma 5 on agent set N with utility function v together with the partition π^* and the special agent $x \in N$. Set $M = \max\{\sum_{w \in N: v(y, w) > 0} v(y, w) : y \in N\}$ and $\alpha = \min_{w \in N: v(x, w) > 0} v(x, w) > 0$. For $i \in [2]$, let $N_i = \{y_i : y \in N\}$ be two copies of N . Accordingly, let π_i^* be their respective copies of π^* .

We define a symmetric ASHG on agent set $N' = N_1 \cup N_2 \cup Z$ where $Z = \{z_k^j : k \in [2], j \in [3]\}$. Define $Z^j = \{z_1^j, z_2^j\}$. Utilities are as follows.

- $v'(y_i, w_i) = v(y, w)$ if $y, w \in N_i$ for $i \in [2]$,
- $v'(z_k^j, x_1) = \alpha/7$, $v'(z_k^j, x_2) = \alpha/8$ for $k \in [2], j \in [3]$,
- $v'(z_1^j, z_2^j) = \alpha$ for $j \in [3]$, and
- $v'(u, y) = -M - 1$ for every pair of agents $u, y \in N'$ such that their utility is not defined, yet.

Note that by Lemma 5, this reduction is in polynomial time.

First assume that (R, S) is a ‘no’-instance. Then, $\sigma^* = \pi_1^* \cup \pi_2^* \cup \{Z^j : j \in [3]\}$ is popular. To prove this, let σ be an arbitrary partition and define $\pi_i = \{\sigma(y) \cap N_i : y \in N_i\}$ be the coalitions restricted to N_i . For each $j \in [3]$, we can assume that $\sigma(z_k^j) = Z^j$ or there exists a $i \in [2]$ with $Z^j \cap \sigma(x_i) \neq \emptyset$. Otherwise, one can obtain a Pareto-improvement σ' over σ and it suffices to prove that $\phi(\sigma^*, \sigma') \geq 0$. Indeed, if $\sigma(z_k^j) = \{z_k^j\}$ for $k \in [2]$, then creating Z^j is a Pareto-improvement. On the other hand, if $\{z_{3-k}, x_1, x_2\} \cap \sigma(z_k^j) = \emptyset$ and $|\sigma(z_k^j)| \geq 2$, then leaving her coalition with z_k^j yields a Pareto-improvement over σ . Hence, if $x_1, x_2 \notin \sigma(z_k^j)$, then $z_{3-k}^j \in \sigma(z_k^j)$ and putting all potential further agents in the coalition into a singleton coalition would yield a Pareto improvement. Hence, we have already substantially restricted the coalitions of agents in a Z^j .

Next, we argue that we may assume that it does not happen that $\sigma(z_k^j) = \{z_k^j\}$. In this case, there exists an $i \in [2]$ with $z_{3-k}^j \in \sigma(x_i)$. We form a partition σ' by adding z_k^j to $\sigma(z_{3-k}^j) = \sigma(x_i)$. This yields a Partition with $N(\sigma^*, \sigma) \subseteq N(\sigma^*, \sigma')$ and $N(\sigma', \sigma^*) \subseteq N(\sigma, \sigma^*)$, hence $\phi(\sigma^*, \sigma') \geq \phi(\sigma^*, \sigma)$, and it suffices to consider the popularity margin between σ^* and σ' .

By a similar argument, we can assume that $\sigma(x_i) \subseteq Z \cup N_i$ (putting all agents outside $Z \cup N_i$ into singleton coalitions has the same effect).

We can therefore partition the agent set N' into sets of the type Z^j such that $\sigma(z_1^j) = Z^j$, of the type N_i such that $Z \cap \sigma(x_i) = \emptyset$, and of the type $N_i \cup \sigma\{x_i\}$ such that $Z \cap \sigma(x_i) \neq \emptyset$. For the first type, $\phi_{Z^j}(\sigma^*, \sigma) = 0$ and by Lemma 5, $\phi_{N_i}(\sigma^*, \sigma) \geq 0$ for the second type of sets. We prove that $\phi_{N_i \cup \sigma\{x_i\}}(\sigma^*, \sigma) \geq 0$ if $Z \cap \sigma(x_i) \neq \emptyset$.

If $\sigma(x_i) \subseteq Z \cup \{x_i\}$, then $x_i \in N(\sigma^*, \sigma)$ and $\phi_{\sigma(x_i) \setminus \{x_i\}}(\sigma^*, \sigma) \geq -2$. As a consequence, $\phi_{N_i \cup \sigma(x_i)}(\sigma^*, \sigma) \geq -2 + \phi(\pi_i^*, \pi_i) \geq 0$ by Lemma 5.

Otherwise, $Z \cap \sigma(x_i) \subseteq N(\sigma^*, \sigma)$ and the only agent in N_i that can be worse off in π_i compared to σ is x_i . Note that the utilities are designed so that $x_i \notin N(\sigma, \sigma^*) \cap N(\pi^*, \pi)$. It follows $\phi_{N_i \cup \sigma(x_i)}(\sigma^*, \sigma) = \phi_{N_i}(\sigma^*, \sigma) + \phi_{\sigma(x_i) \cap Z}(\sigma^*, \sigma) \geq \phi_{N_i}(\sigma^*, \sigma) + 1 \geq -1 + \phi(\pi_i^*, \pi_i) + 1 \geq 0$.

Together, it is shown that σ^* is popular.

Conversely, assume that (R, S) is a ‘yes’-instance and assume for contradiction that σ is popular and define $\pi_i = \{\sigma(y) \cap N_i : y \in N_i\}$ as above. The Pareto-improvements of the first implication show that for all j , $Z^j \in \sigma$ or $\sigma(x_i) \cap Z^j \neq \emptyset$. Define $I = \{i \in [2] : Z \cap \sigma(x_i) \neq \emptyset\}$. The first crucial step is to prove that for all $i \in I$, it holds that there exists a $j \in [3]$ with $\sigma(x_i) = \{x_i\} \cup Z^j$.

Let therefore $i \in I$. First, $\sigma(x_i) \cap N_i = \{x_i\}$ since otherwise splitting $\sigma(x_i)$ into singleton coalitions is more popular. In addition, $x_{3-i} \notin \sigma(x_i)$. If this happens and $|\sigma(x_i) \cap Z| \neq 2$, then splitting into singleton coalitions is more popular. On the other hand, if $|\sigma(x_i) \cap Z| = 2$, there exists $j^* \in [3]$ with $Z^{j^*} \in \sigma$. We form the partition σ' by leaving her coalition with x_1 and forming $\{x_1, z_1^{j^*}, z_2^{j^*}\}$. Then, $\{x_1, x_2, z_1^{j^*}, z_2^{j^*}\} \subseteq N(\sigma', \sigma)$ while $N(\sigma, \sigma') \subseteq \sigma(x_i) \cap Z$. Hence, σ' is more popular.

Hence, $\sigma(x_i) \subseteq Z \cup \{x_i\}$. If for $j \neq j^*$, $Z^j \cap \sigma(x_i) \neq \emptyset$ and $Z^{j'} \cap \sigma(x_i) \neq \emptyset$, then dissolving $\sigma(x_i)$ is again more popular. Finally, if $|\sigma(x_i) \cap Z| = 1$, we find again a $j^* \in [3]$ with $Z^{j^*} \in \sigma$. We form the partition σ' by forming $\pi(x_i) \cap Z$ and $\{x_i, z_1^{j^*}, z_2^{j^*}\}$ which is more popular.

The next step is to show that $I = \{1, 2\}$. Assume for contradiction that $Z \cap \sigma(x_i) = \emptyset$. Then we can assume that for all $y \in N_i$, $\sigma(y) \subseteq N_i$. If $\pi_i \neq \pi_i^*$, then replacing π_i by π_i^* is more popular (by Lemma 5). Otherwise $\pi_i = \pi_i^*$ and we consider the partition π_i' of the last part of Lemma 5 for N_i . By the pigeon hole principle, there exists a $j^* \in [3]$ with $Z^{j^*} \in \sigma$. We obtain $\sigma' = (\sigma \setminus (\pi_i \cup \{Z^{j^*}\})) \cup ((\pi_i' \setminus \{\{x_i\}\}) \cup \{\{x_i, z_1^{j^*}, z_2^{j^*}\}\})$. Then, $\phi(\sigma', \sigma) = \phi_{N_i \cup Z^{j^*}}(\sigma', \sigma) = -1 + 2 = 1$ and σ' is more popular.

Together, we can assume that there exist $j_1, j_2 \in [3]$ with $\sigma(x_i) = \{x_i, z_1^{j_i}, z_2^{j_i}\}$, for $i \in [2]$. Let $j_3 \in [3] \setminus \{j_1, j_2\}$ be the third index. Note that $Z^{j_3} \in \sigma$. Define $\sigma' = (\sigma \setminus \{\sigma(z_1^{j_1}) : j \in [3]\}) \cup \{\{x_1, z_1^{j_2}, z_2^{j_2}\}, \{x_2, z_1^{j_3}, z_2^{j_3}\}, Z^{j_1}\}$. Then, $N(\sigma', \sigma) = Z^{j_2} \cup Z^{j_3}$ while $N(\sigma, \sigma') = Z^{j_1}$. Hence, σ' is more popular.

All in all, it is shown that there exists no popular partition if (R, S) is a ‘yes’-instance. This concludes the proof of the theorem. \square

A.4 Fractional Hedonic Games

Before investigating popularity, we quote a useful proposition about the structure of top-ranked coalitions in FHGs.

Proposition 10 (Bullinger (2020)). *Let a FHG (N, \succeq) be given and let $i \in N$ be an agent. Let μ be the utility of a top-ranked coalition of agent i . Then, the top-ranked coalitions of agent i are precisely the coalitions of the form $\{i\} \cup \{j \in N : v_i(j) > \mu\} \cup W$ for $W \subseteq \{j \in N : v_i(j) = \mu\}$.*

In other words, every top-ranked coalition of agent i consists precisely of all agents j whose utility $v_i(j)$ exceeds a certain threshold.

In the reductions for the existence and verification problem, there exist gadgets for every element of R and the sets in S . The R -gadgets rely on rather simple graphs, namely stars.

We define by S_k the star graph with k leaves, i.e., $S_k \cong G$, where $G = (V, E)$ with $V = \{c, l_1, \dots, l_k\}$, $E = \{\{c, l_j\} : j \in [k]\}$. We say that an FHG is induced by S_k if its agent set is $N = V$, and symmetric, binary utilities are given by $v(i, j) = 1$ if $\{i, j\} \in E$ and $v(i, j) = 0$, otherwise, where $i, j \in N$. The next proposition classifies, which star graphs induce FHGs admitting popular partitions. The boundary cases are illustrated in Figure 5.

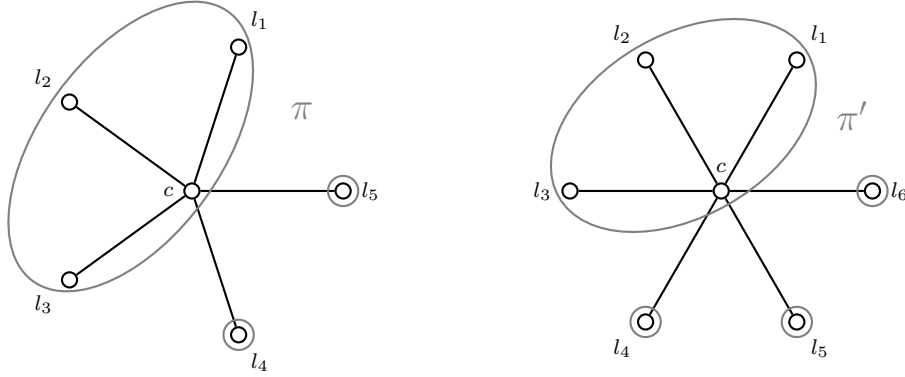

Figure 5: FHGs induced by stars. For stars with 5 leaves, a popular partition π exists (left). This is not the case for stars with more leaves. For instance, the grand coalition is more popular than partition π' (right).

Proposition 11. *Let $k \in \mathbb{N}$ and consider the FHG induced by S_k . For $k \leq 5$, the (sub-)partition (of) $\pi = \{\{c, l_1, l_2, l_3\}, \{l_4\}, \{l_5\}\}$ is popular. For $k \geq 6$, S_k admits no popular partition.*

Proof. The first part is easily seen.

For the second assertion, let $k \geq 6$ and assume that π was a popular partition. Then, $|\pi(c)| \leq 4$, since otherwise we obtain a more popular partition if one leaf leaves $\pi(c)$. But in this case, the grand coalition is more popular (having c and at least $k - 3$ leaves better off). \square

Using stars as gadgets, we can prove the next theorem.

Theorem 21. *Checking whether there exists a popular partition in a symmetric FHG is NP-hard, even if all utilities are non-negative.*

Proof. The reduction is from X3C to deciding whether there exists a popular partition.

Let (R, S) be an instance of X3C. We transform it into an FHG (N, \succsim) defined by the graph $G = (N, E)$ that is given as follows:

$N = \{c^r, l_j^r : r \in R, j \in [6]\} \cup \{y^s, z_j^s : s \in S, j \in [2]\}$ and $E = E^R \cup E^C \cup E_6 \cup E^S$ where $E^R = \{\{c^r, l_j^r\} : r \in R, j \in [6]\}$, $E^C = \{\{l_6^s, y^s\} : s \in S, r \in s\}$, $E_6 = \{\{l_6^r, l_6^t\} : r \neq t, r, t \in s \text{ for } s \in S\}$, $E^S = \{\{y^s, z_j^s\}, \{z_1^s, z_2^s\} : s \in S, j \in [2]\}$. The edge set E^C connects the gadgets for the ground set and the subsets for the X3C instance.

The weights are 1, except $v(e) = \frac{1}{2}$ for $e \in E^C$ and $v(e) = \frac{1}{4}$ for $e \in E_6$. A schematic of the reduction for a certain set $s = \{i, j, k\} \in S$ is depicted in Figure 6.

We show that there exists a popular partition of (N, \succsim) if and only if (R, S) is a ‘yes’ instance of X3C.

Assume (R, S) is a ‘yes’ instance of X3C. Then, there exists $S' \subseteq S$ such that S' is a partition of R . The following partition π is then popular: $\pi = \{\{c^r, l_1^r, l_2^r, l_3^r\} : r \in R\} \cup \{\{l_j^r\} : r \in R, j = 4, 5\} \cup \{\{y^s, l_6^i, l_6^j, l_6^k\} : s = \{i, j, k\} \in S'\} \cup \{\{z_1^s, z_2^s\} : s \in S'\} \cup \{\{y^s, z_1^s, z_2^s\} : s \in S \setminus S'\}$.

Assume for contradiction that π' is more popular than π and let π be with $\phi(\pi, \pi')$ maximal. We will prove that $\phi(\pi, \pi') \geq 0$, a contradiction.

We introduce some notation for the proof. $V^r = \{c^r, l_j^r : j \in [6]\}$, where $r \in R$, and $W^s = \{y^s, z_1^s, z_2^s\}$, where $s \in S$. Also denote $V^R = \cup_{r \in R} V^r$, $W^S = \cup_{s \in S} W^s$ and $A_6 = \{a_6^r : r \in R\}$ and $Y^c = \{s \in S : \exists a \in A_6 \text{ with } a \in \pi'(y^s)\}$.

To derive a contradiction, we prove several claims.

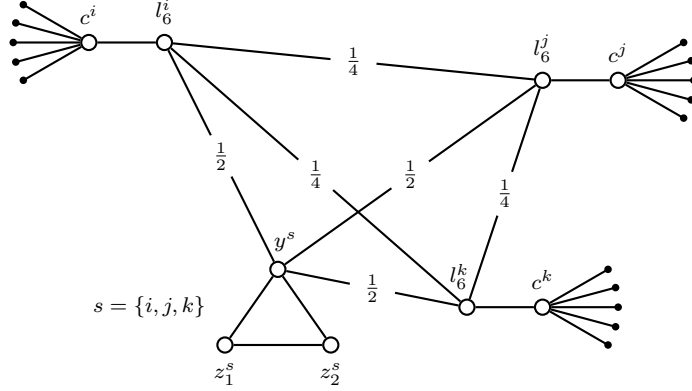

Figure 6: Reduction for existence problem of popular partitions in FHGs. The schematic displays the part of the network corresponding to one specific set $s = \{i, j, k\}$.

1. Let $r \in R$ such that for all $s \in S$, $y^s \notin \pi'(a_6^r)$. Then $\phi_{V^r} \geq 1$.
2. $\nexists r \in R, s, s' \in S$ with $s \neq s'$ and $\{y^s, y^{s'}\} \subseteq \pi'(a_6^r)$.
3. $\forall s \in S$ holds: $\pi'(y^s) \cap W^s = \{y^s\} \vee \pi'(y^s) \subseteq W^s$.
4. For all $r \in R$, $\phi_{V^r}(\pi, \pi') \geq 0$.
5. $\phi_{W^s}(\pi', \pi) \leq |R| - 3|Y^c|$.

The first claim says that we need sufficient external influence for V^r to be locally popular. The second and third claim give insight on the structure of possible more popular partitions. The fourth claim shows that we locally do best for every V^r . The final claim calculates the tradeoff between forming a coalition W^s and joining the agents in V^r .

In order to complete the proof from the claims, we apply claims 1 and 4 to obtain $\phi_{V^R}(\pi, \pi') \geq \max\{0, |R| - 3|Y^c|\} \geq |R| - 3|Y^c|$. Combining this inequality with the one of Claim 5 yields $\phi(\pi, \pi') \geq 0$.

The first claim is a straightforward case distinction considering $\pi'(c^r)$. Observe that by construction of its neighboring agents, $a_6^r \in N(\pi, \pi') \vee a_6^r \in \pi'(c^r)$. This property makes it equivalent to the agents a_5^r and a_4^r in the analysis.

We proceed with the second claim. Therefore, assume for contradiction that $r \in R, s, s' \in S$ with $s \neq s'$ and $\{y^s, y^{s'}\} \subseteq \pi'(a_6^r)$. We denote $C = \pi'(a_6^r)$ for this part. We claim that we can change π' while strictly increasing $\phi(\pi', \pi)$. This is done by forming a partition π'' that consists of coalitions W^t whenever $y^t \in C$. The agents outside W^s in C form a coalition of their own. Other coalitions are not changed.

- Let $t \in S$ with $y^t \in C$. If $\pi(y^t) = W^t$, then $W^t \subseteq N(\pi, \pi')$. This is immediate for the z_j^t . In addition, by assumption on C , at least 3 agents are present, and the utility is estimated as $v_{y^t}(\pi') \leq \max\{\frac{1}{3}, \frac{3}{4}, \frac{5}{5}, \frac{6}{6}, \frac{7}{7}\} = \frac{1}{2} < \frac{2}{3} = v_{y^t}(\pi)$
- If $\pi(y^t) \neq W^t$, then $z_1^t, z_2^t \notin N(\pi', \pi)$ and $y^t \notin N(\pi', \pi) \vee (\exists i : z_i^t \in N(\pi, \pi'))$.

Define $Y = |\{t \in S : y^t \in C\}|$. These first two insights yield, that $\phi_{\{W^s : s \in Y\}}(\pi'', \pi) \geq 3|Y| + \phi_{\{W^s : s \in Y\}}(\pi', \pi)$. There is an increase of at least 6 by the assumption that $\{y^s, y^{s'}\} \subseteq C$.

- The only agents that can decrease (π'', π) compared to (π', π) are in A_6 . Note that if $a \in A_6 \cap C$ has at most one neighbor in Y , then for some p (the number of neighbors in A_6), $v_a(\pi') = \frac{\frac{1}{2} + \frac{p}{4}}{3+p} < \frac{1}{4} = v_a(\pi)$. Define the improving agents in A_6 via $\mathcal{I} = C \cap A_6 \cap N(\pi', \pi)$ and the non-worsened agents as $\mathcal{I}' = C \cap A_6 \setminus (\mathcal{I} \cup N(\pi, \pi'))$.

- If $|\mathcal{I}| \leq 2$, then $\phi_{C \cap A_6}(\pi'', \pi) \geq \phi_{C \cap A_6}(\pi', \pi) - 4$ (the agents in \mathcal{I} each counted twice for being worse instead of better off).
- If $|\mathcal{I}| \geq 3$, we know that $|Y| \geq 3$ (otherwise, three agents in \mathcal{I} are incident to the same two y^t , but then in the instance of X3C, we had two identical 3-elementary sets). This means for any $a \in A_6 \cap C$ that has exactly two neighbors in Y that for some p , $v_a(\pi') \leq \frac{1 + \frac{p}{4}}{4+p} = \frac{1}{4}$. Hence, $a \notin N(\pi', \pi)$.

Agents in \mathcal{I} need therefore three neighbors in Y and agents in \mathcal{I}' two. Since every agent in Y has at most three neighbors, this accumulates to $|Y| \geq |\mathcal{I}| + \frac{2}{3}|\mathcal{I}'|$.

Consequently, for $M = C \cap (A_6 \cup W^S)$,

$$\begin{aligned} \phi(\pi'', \pi) &= \phi_{N \setminus M}(\pi'', \pi) + \phi_{C \cap A_6}(\pi'', \pi) + \phi_{W^S \cap C}(\pi'', \pi) \\ &\geq \phi_{N \setminus M}(\pi', \pi) + \phi_{C \cap A_6}(\pi', \pi) - 2|\mathcal{I}| - |\mathcal{I}'| + \phi_{W^S \cap C}(\pi', \pi) + 3|Y| \\ &> \phi(\pi', \pi). \end{aligned}$$

In both cases, we contradict the maximality of $\phi(\pi', \pi)$.

The third claim is proven similarly, but we have to refine some calculation of the previous claim, since we do not get the same lower bounds for the denominators of the utilities.

Assume for contradiction that $s \in S$ with $\pi'(y^s) \cap A_6 \neq \emptyset$ and $\pi'(y^s) \cap W^s \neq \emptyset$. We set $C = \pi'(y^s)$.

- First, we argue that we may assume that $A_6 \cap C \cap N(\pi', \pi) = \emptyset$. Otherwise, by the previous claim, if $a_6^r \in A_6 \cap C \cap N(\pi', \pi)$, then $c^r \in C$. Consequently, $a_j^r \in N(\pi, \pi')$ for $j \in [3]$ and $c^r \in N(\pi, \pi')$. The latter is due to $v_{c^r}(\pi') \leq \frac{6}{9} < \frac{3}{4} = v_{c^r}(\pi)$. Also, $(\exists j \in \{4, 5\} : a_j^r \notin C) \vee a_6^r \notin N(\pi', \pi)$. Indeed, if the first is wrong, then for some p , $v_{a_6^r}(\pi') \leq \frac{1 + \frac{1}{2} + \frac{p}{4}}{6+p} = \frac{1}{4} = v_{a_6^r}(\pi)$. Hence resetting the coalition within V^r to π yields a coalition contradicting the maximality of $\phi(\pi', \pi)$.
- We consider two cases. First assume that $\pi(y^s) \neq W^s$. We claim that rearranging π' by means of removing agents of W^s from $\pi'(y^s)$ improves $\phi(\pi', \pi)$. Indeed, $z_j^s \notin N(\pi', \pi)$, but they will be after the rearrangement, and $y^s \in N(\pi', \pi)$ afterwards. Also, for all $a \in A_6 \cap C$, $v_a(\pi') \leq \frac{\frac{1}{2} + \frac{p}{4}}{p+3} < \frac{1}{4}$ and these agents are already worse off in the original π' .
- If $\pi(y^s) = W^s$, the same holds for agents in $A_6 \cap C$. Since $W^s \subseteq N(\pi, \pi')$, the same rearrangement improves $\phi(\pi', \pi)$.

We proceed with the next claim and fix $r \in R$. We may assume that for some s , $y^s \in \pi'(a_6^r)$ (since the other case is already covered in the first claim). In addition, if $c^r \notin \pi'(a_6^r)$, then $a_6^r \notin N(\pi', \pi)$ (by the previous claims). In this case, the coalition π restricted to $V^r \setminus \{a_6^r\}$ is popular and the claim is true.

Denote $C = \pi'(a_6^r)$ and assume therefore $c^r \in C$. We also know that $\{a_1, a_2, a_3\} \cap N(\pi', \pi) = \emptyset$ and $|\{a_1, a_2, a_3\} \cap N(\pi, \pi')| \geq 2$. Consequently, if $\{a_4, a_5\} \cap C = \emptyset$, we are done. If $\{a_4, a_5\} \cap C \neq \emptyset$, $\{a_1, a_2, a_3\} \subseteq N(\pi, \pi')$. Putting the final case together, $|N(\pi', \pi)| \leq 3$ while $|N(\pi, \pi')| \geq 3$ and the claim is true.

For the fifth claim, we consider the coalitions in π for different y^s :

- If $W^s = \pi(y^s)$, then $W^s \cap N(\pi', \pi) = \emptyset$ (by Claim 3) and if $s \in Y^c$, then $W^s \subseteq N(\pi, \pi')$. This gives $|N(\pi, \pi') \cap W^S| \geq 3|\{s \in Y^c: \pi(y^s) = W^s\}|$.
- If $W^s \neq \pi(y^s)$ and $s \in Y^c$, then $W^s \cap N(\pi', \pi) = \emptyset$ (again using Claim 3). Consequently, $|N(\pi', \pi) \cap W^S| \leq 3|\{s \notin Y^c: \pi(y^s) \neq W^s\}|$.

Combining the inequalities yields

$$\begin{aligned}
& |N(\pi', \pi) \cap W^S| - |N(\pi, \pi') \cap W^S| \\
& \leq 3(|\{s \notin Y^c: \pi(y^s) \neq W^s\}| - |\{s \in Y^c: \pi(y^s) = W^s\}|) \\
& = 3(|\{s \notin Y^c: \pi(y^s) \neq W^s\}| + |\{s \in Y^c: \pi(y^s) \neq W^s\}| \\
& \quad - |\{s \in Y^c: \pi(y^s) = W^s\}| - |\{s \in Y^c: \pi(y^s) = W^s\}|) \\
& = 3|S'| - 3|Y^c| = |R| - 3|Y^c|.
\end{aligned}$$

This proves the final claim and we have proved that ‘yes’-instances of X3C map to popular partitions of the FHG.

For the reverse implication, assume that π is a popular partition. We exhibit the coalitions of the agents in A_6 .

1. For all $r \in R$, there exists a unique $s \in S$ with $y^s \in \pi(a_6^r)$. For this s holds that $r \in s$.
2. For all $r \in R$, $|A_6 \cap \pi(a_6^r)| = 3$.

If the claims are true, $S' = \{s \in S : A_6 \cap \pi(y^s) \neq \emptyset\}$ covers R due to existence and is a partition due to uniqueness and the fact, that uniqueness and the second claim imply that the coalition of the unique y^s must contain precisely a_6^i for $i \in s$.

We start with the first claim. Existence is clear because otherwise the subpartition of π on V^r (possibly restricted to V^r) is popular on V^r , contradicting Proposition 11.

For uniqueness, assume for contradiction that there is $r \in R$ and $s \neq s' \in S$ with $\{y^s, y^{s'}\} \subseteq \pi(a_6^r)$. We obtain a more popular coalition π' as follows: remove the agents in W^s from their partitions in π and let them form a coalition. Then $W^s \cup \{y^{s'}\} \subseteq N(\pi', \pi)$ and $N(\pi, \pi') \subseteq \{a_6^r: r \in s\}$. Hence, π' is more popular.

For the second claim, we know due to uniqueness in the first claim that $|A_6 \cap \pi(a_6^r)| \leq 3$. Assume for contradiction that $|A_6 \cap \pi(a_6^r)| < 3$ and let $y^s \in \pi(a_6^r)$. Then, the same coalition π' as in the proof of the previous claim is more popular. This time, $W^s \subseteq N(\pi', \pi)$ and $N(\pi, \pi') \subseteq \{a_6^r: r \in s\}$, hence by assumption $|N(\pi, \pi')| \leq 2$. □

Theorem 22. *Checking whether a given partition in a symmetric FHG is popular is coNP-complete, even if all utilities are non-negative and the underlying graph is bipartite.*

Proof. First of all, the verification problem is in coNP, because a more popular partition serves as a polynomial-time certificate for a ‘no’-instance.

For hardness, we reduce again from X3C. Given an instance (R, S) of X3C, we assume without loss of generality that $|R| \geq 6$. We define an FHG (N, \succ) given by the underlying graph $G = (N, E)$ depicted in Figure 7 and defined as:

$$N = R \cup \{s_1, s_2, s_3: s \in S\} \cup \{b_1, b_2, b_3\}, E = \{\{s_3, r\}: r \in R \cap s\} \cup \{\{s_1, s_3\}, \{s_2, s_3\}: s \in S\} \cup \{\{s_j, b_j\}: s \in S, j \in [2]\} \cup \{\{b_1, b_3\}, \{b_2, b_3\}\}.$$

The symmetric weights v are given as

- $v(i, s_3) = \frac{1}{2}$ if $i \in s$,
- $v(s_1, s_3) = v(s_2, s_3) = 1$ for $s \in S$,

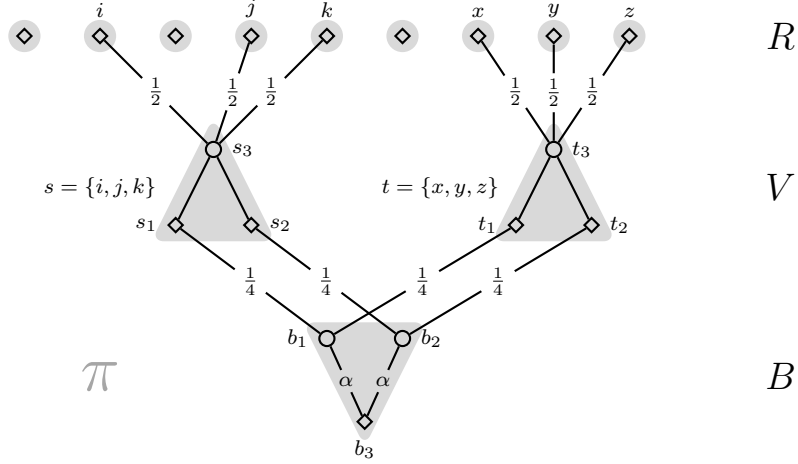

Figure 7: Schematic of the reduction for the verification problem of popular partitions on bipartite FHGs. The bipartition is indicated by the shapes of the agents. The partition π under consideration is marked in gray.

- $v(s_j, b_j) = \frac{1}{4}$ for $s \in S, j \in [2]$, and
- $v(b_1, b_3) = v(b_2, b_3) = \alpha$ for $\frac{3(|R|-3)}{4|R|} < \alpha < \frac{3|R|}{4(|R|+3)}$.

One can choose α with a size bounded polynomially in the input size. For the reduction, only the above bounds matter. We introduce the same notation as in the proof for ASHG. Denote $V^s = \{s_1, s_2, s_3\}$ for $s \in S$, $B = \{b_1, b_2, b_3\}$, and $V = \cup_{s \in S} V^s$.

G is bipartite with bipartition $(R \cup \{s_1, s_2 : s \in S\} \cup \{b_3\}, \{s_3 : s \in S\} \cup \{b_1, b_2\})$ and all weights on present edges are positive.

The verification problem is asked for the partition $\pi = \{V^s : s \in S\} \cup \{\{r\} : r \in R\} \cup \{B\}$. We claim that (R, S) is a ‘yes’-instance of X3C if and only if π is not popular for the FHG given by G .

If (R, S) is a ‘yes’-instance, there exists a subset $S' \subseteq S$ that partitions R . In particular $|R| = 3|S'|$.

Consider the partition given by $\pi' = \{V^s : s \in S \setminus S'\} \cup \{\{s_3, i, j, k\} : \{i, j, k\} = s \in S'\} \cup \{\{b_j, s_j : s \in S'\} : j \in [2]\} \cup \{\{b_3\}\}$.

Then, for $j \in [2]$, $v_{b_j}(\pi') = \frac{\frac{1}{4}|S'|}{|S'|+1} = \frac{|R|}{4(|R|+3)} > \frac{\alpha}{3} = v_{b_j}(\pi)$. Since all agents in R have clearly improved their utility, $R \cup \{b_1, b_2\} \subseteq N(\pi', \pi)$ (and in fact equality holds here). Moreover, the utilities of agents in V^s for $s \in S \setminus S'$ have not changed. Consequently, $N(\pi, \pi') \subseteq \cup_{s \in S'} V^s \cup \{b_3\}$. Hence, π' is more popular than π .

Conversely, assume that there exists a more popular partition π' and fix one that maximizes $\phi(\pi', \pi)$. We have to prove that there exists a subset $S' \subseteq S$ that yields a partition of R .

First, we make the observation that if $b_j \in N(\pi', \pi)$ for $j \in [2]$, then $b_3 \in N(\pi, \pi')$. Hence, $\phi_B(\pi', \pi) \leq 1$.

Second, we claim that for all $s \in S$, $N(\pi', \pi) \cap V^s = \emptyset$. Clearly, $s_3 \notin N(\pi', \pi)$ (by construction, since she receives a top coalition with respect to the given utilities). Assume for $j \in [2]$, $s_j \in N(\pi', \pi)$. Then, $\pi'(s_j) = \{s_j, s_3, b_j\}$. Note that both neighbors of s_j are needed to improve utility, but no other agent may be present since for $|\pi'(s_j)| \geq 4$ follows $v_{s_j}(\pi') \leq \frac{5}{4} < \frac{1}{3} = v_{s_j}(\pi)$. In addition, $s_{3-j}, b_3 \in N(\pi, \pi')$.

We form a new coalition π'' from π' by having the coalitions V^s and B and all other coalitions remain the same. The exact same case distinction for b_{3-j} as in the case of ASHG's yields a contradiction to the maximality condition on π' .

The remainder of the proof follows a similar strategy as the one for ASHG's, but some arguments are more tedious.

To make this more formal, we introduce the sets $R_I = R \cap N(\pi', \pi)$ of agents in R that form a coalition with a neighbor in π' and $S_C = \{s \in S: \pi'(s_3) \cap R \neq \emptyset\}$. The latter is the set of critical sets in S whose corresponding agents s_3 form a coalition with agents in R . We split it into $S_{C,1} = \{s \in S: |\pi'(s_3) \cap R| = 1\}$ and $S_{C,2} = S_C \setminus S_{C,1}$.

We have the following facts:

- For $s \in S_C$, $s_3 \in N(\pi, \pi')$.
- For $s \in S_{C,1}$, $s_1 \in N(\pi, \pi') \vee s_2 \in N(\pi, \pi')$.
- For $s \in S_{C,2}$, $s_1 \in N(\pi, \pi') \wedge s_2 \in N(\pi, \pi')$.

Consequently, $|N(\pi, \pi') \cap V| \geq 2|S_{C,1}| + 3|S_{C,2}|$. In addition, $|N(\pi', \pi) \cap R| = |R_I| \leq |S_{C,1}| + 3|S_{C,2}|$.

If $S_{C,1} \neq \emptyset$, then $\phi(\pi, \pi') = \phi_B(\pi, \pi') + \phi_V(\pi, \pi') + \phi_R(\pi, \pi') \geq -1 + 2|S_{C,1}| + 3|S_{C,2}| - (|S_{C,1}| + 3|S_{C,2}|) = |S_{C,1}| - 1 \geq 0$ and π' is not more popular. We conclude that $S_{C,1} = \emptyset$ or equivalently $S_C = S_{C,2}$.

A similar calculation excludes the case $|R_I| < 3|S_{C,2}|$ which means $|R_I| = 3|S_{C,2}|$.

We claim that in fact $|R| = 3|S_C| = 3|S_{C,2}|$. Before we prove this, we show the same two auxiliary claims as for ASHG's.

1. If $B \subseteq \pi'(b_3)$ then $b_1 \notin N(\pi', \pi) \vee b_2 \notin N(\pi', \pi)$.
2. For $j \in [2]$, if $b_j \in N(\pi', \pi)$, then $b_j \in \pi'(b_3) \vee |\{s \in S: s_j \in \pi'(b_j)\} \cap \pi'(b_j)| \geq \frac{|R|}{3}$.

For the first claim, assume that $B \subseteq \pi'(b_3)$ and $b_1, b_2 \in N(\pi', \pi)$. Denote $p_j = |\{s \in S: s_j \in \pi'(b_j)\}|$. We know that $p_j \geq 1$, since otherwise $b_j \notin N(\pi', \pi)$.

The function $x \mapsto \frac{3(x-3)}{4x}$ is monotonically increasing for $x > 0$. Thus, by the lower bound on α , we know that $\alpha > \frac{3}{8}$ (using $|R| \geq 6$).

Let $j \in [2]$ with $p_j = \min\{p_j, p_{3-j}\}$. Then $|\pi'(b_3)| \geq 3 + 2p_j$. We compute $v_{b_j}(\pi) - v_{b_j}(\pi') = \frac{\alpha}{3} - \frac{\alpha + \frac{p_j}{4}}{3 + 2p_j} = \frac{p_j}{3(3 + 2p_j)}(2\alpha - \frac{3}{4}) > 0$. Hence, $b_j \notin N(\pi', \pi)$, a contradiction.

For the second claim, let $j \in [2]$ with $b_j \in N(\pi', \pi)$ and assume $b_j \notin \pi'(b_3)$. Similarly as before, let $p = |\{s \in S: s_j \in \pi'(b_j)\}|$. Note that $v_{b_j}(\pi) = \frac{\alpha}{3} > \frac{|R|-3}{4|R|} = \frac{1}{4} \frac{\frac{|R|}{3}-1}{(\frac{|R|}{3}-1)+1}$.

Therefore, $v_{b_j}(\pi) < v_{b_j}(\pi') \leq \frac{1}{4} \frac{p}{p+1}$ only if $p > \frac{|R|}{3} - 1$ and since p is an integer, this implies $p \geq \frac{|R|}{3}$.

The remainder of the proof is identical to the one for ASHG's (Theorem 16). \square

The underlying graph for deriving property R for FHGs is almost identical to the one for ASHG's, which might be surprising, because the utilities for ASHG's and FHGs induced by the same graph will in general cause very different preferences over coalitions. However, all coalitions that actually matter for the particular instance we consider are of size 2 and 3 and therefore the different game models behave very similarly.

Lemma 6. *The class of symmetric FHGs with non-negative utility functions satisfies property R.*

Proof. Let (R, S) be an instance of X3C. We construct the following game. Let $k = \min\{k \in \mathbb{N} : 2^k \geq |R|\}$ define the smallest power of 2 that is larger than the cardinality of R . We define a symmetric FHG with non-negative utility functions on vertex set $N = \{v_1^s, v_2^s : s \in S\} \cup \{y_1, y_2\} \cup \bigcup_{j=0}^k N_j$, where $N_j = \bigcup_{i=1}^{2^j} A_j^i$ consists of 2^j sets of agents A_j^i .

We define the sets of agents as

- $A_k^i = \{a_k^i, b_k^i, c_k^i\}$ for $i \in [2^k]$, and
- $A_j^i = \{a_j^i, b_j^i, c_j^i, \alpha_j^i, \beta_j^i, \gamma_j^i, \delta_j^i\}$ for $j \in [0, k-1], i \in [2^j]$.

We order the set R in an arbitrary but fixed way, say $R = \{r^1, \dots, r^{|R|}\}$ and for a better understanding of the proof and the preferences, we label the agents $b_k^i = r^i$ for $i \in [|R|]$. If we view the set of agents N as $k+1$ levels of agents, then the ground set R of the instance of X3C is identified with some specific agents in the top level k . We are ready to define the preferences.

- $v(v_1^s, v_2^s) = \frac{21}{10}(k+1)$ for all $s \in S$,
- $v(v_2^s, b_k^i) = \frac{3}{2}(k+1)$ if there exists $s \in S$ with $r^i \in s$,
- $v(y_1, y_2) = 1$,
- $v(y_2, b_k^i) = 2^{k+2}(k+1)$, $i \in [|R|+1, 2^k]$,
- $v(b_k^i, b_k^{i'}) = 0$, $i, i' \in [|R|+1, 2^k]$,
- $v(b_k^i, b_k^{i'}) = \frac{2}{3}(k+1)$, $i, i' \in [|R|]$,
- $v(a_k^i, b_k^i) = v(a_k^i, c_k^i) = v(b_k^i, c_k^i) = k+1$, $i \in [2^k]$,
- For $j \in [0, k-1], i \in [2^k]$,
 - $v(a_j^i, b_j^i) = v(a_j^i, c_j^i) = j+1$, $v(b_j^i, c_j^i) = j+1.5$,
 - $v(b_j^i, c_{j+1}^{2^i-1}) = v(b_j^i, c_{j+1}^{2^i}) = j+1.5$,
 - $v(\alpha_j^i, \beta_j^i) = j+1$, $v(\beta_j^i, \gamma_j^i) = \frac{j}{2}$,
 - $v(\beta_j^i, a_j^i) = j+1.75$, $v(\gamma_j^i, a_j^i) = j+1.25$,
 - $v(\gamma_j^i, \delta_j^i) = j+2$, $v(\delta_j^i, \alpha_{j+1}^{2^i-1}) = v(\delta_j^i, \alpha_{j+1}^{2^i}) = j+1.6$, and
- $v(g, h) = 0$ for all $g, h \in N$ such that the utility is not defined, yet.

Let $\pi^* = \{\{a_j^i, b_j^i, c_j^i\} : j \in [0, k], i \in [2^j]\} \cup \{\{\alpha_j^i, \beta_j^i\}, \{\gamma_j^i, \delta_j^i\} : j \in [0, k-1], i \in [2^j]\} \cup \{\{y_1, y_2\}\} \cup \{\{v_1^s, v_2^s\} : s \in S\}$ and $x = c_0^1$.

Now consider a partition $\pi \neq \pi^*$.

We will prove the following claim by induction over $j = k, \dots, 0$. For every $i \in [2^j]$ holds:

1. If $\{b_j^i, a_j^i\} \cap \pi(c_j^i) = \emptyset$, then $\phi_{T_j^i}(\pi^*, \pi) \geq 1$ and $\phi_{T_j^i}(\pi^*, \pi) \geq 3$ or $\{b_k^i : i \in [2^k]\} \cap T_j^i \subseteq N(\pi, \pi^*)$.
2. If $\alpha_j^i \notin N(\pi, \pi^*)$ and there exists an agent $z \in T_j^i$ with $\pi(z) \neq \pi^*(z)$. Then $\phi_{T_j^i}(\pi^*, \pi) \geq 1$.

We will start by arguing, how the first part of the lemma follows from the induction claim.

First, note that $y_1 \notin N(\pi, \pi^*)$ and if $y_2 \in N(\pi, \pi^*)$, then $y_1 \in N(\pi^*, \pi)$. Similarly, for all $s \in S$, $v_1^s \notin N(\pi, \pi^*)$ and if $v_2^s \in N(\pi, \pi^*)$, then $v_1^s \in N(\pi^*, \pi)$. We can therefore focus on T_0^1 and have $\phi(\pi^*, \pi) \geq \phi_{T_0^1}(\pi^*, \pi)$. Define $\rho = \{C \cap T_0^1 : C \in \pi\}$ and $\rho^* = \{C \cap T_0^1 : C \in \pi^*\}$, which are the partitions π and π^* restricted to agents in T_0^1 . If $\rho = \rho^*$, then $\pi \neq \pi^*$ can only happen if some agent outside T_0^1 forms a coalition with a former coalition of π^* in T_0^1 . Note that the only agents in T_0^1 that can improve by that are the agents of the type b_k^i . In every case, this will lead to $\phi_{T_0^1}(\pi^*, \pi) \geq 1$. As we have argued above, this implies $\phi(\pi^*, \pi) \geq 1$.

If $\rho \neq \rho^*$, we use the claim for the case $j = 0$ and observe that $\alpha_0^i \notin N(\pi, \pi^*)$. Hence, $\phi(\pi^*, \pi) \geq 1$ also holds in this case.

It needs still to be shown that if $\pi(x) \cap \pi^*(x) = \{x\}$, then $\phi(\pi^*, \pi) \geq 3$ or (R, S) is a ‘yes’-instance. Assume therefore that $\pi(x) \cap \pi^*(x) = \{x\}$. By the first part of the induction claim, we conclude that $\phi_{T_0^1}(\pi^*, \pi) \geq 3$ or $\{b_k^i : i \in [2^k]\} \subseteq N(\pi, \pi^*)$. Since we are done in the former case, we assume that $\{b_k^i : i \in [2^k]\} \subseteq N(\pi, \pi^*)$. This can only happen if, for every $i \in 1, \dots, |R|$, there exists an $s_i \in S$ with $v_2^{s_i} \in \pi(b_k^i)$. Indeed, if this is not the case, then the utility of b_k^i is bounded by $\frac{2(k+1) + \frac{2\lambda}{3}(k+1)}{3+\lambda} = \frac{2}{3}(k+1) = v_{b_k^i}(\pi^*)$, where $\lambda = |\{b_k^j : j \in [R] \cap (\pi(b_k^i) \setminus \{b_k^i\})\}|$. Note that the equality is true for every $\lambda \geq 0$. Hence, $b_k^i \notin N(\pi, \pi^*)$.

Define $S' = \{s \in S : \pi(s_2) \cap \{b_k^i : i \in [R]\} \neq \emptyset\}$. Now fix $s \in S'$ and define $C = \pi(v_2^s)$. We deal first with the case that $v_1^s \in C$ and let $r^i \in R$ with $b_k^i \in C$. We claim that $a_k^i, c_k^i \in C$. Otherwise, for some $\lambda \geq 0$, $v_{b_k^i}(\pi) \leq \frac{\frac{3}{2}(k+1) + (k+1) + \frac{2\lambda}{3}(k+1)}{4+\lambda} < \frac{2}{3}(k+1) = v_{b_k^i}(\pi^*)$, and $b_k^i \notin N(\pi, \pi^*)$, which is a contradiction. Hence, $a_k^i, c_k^i \in C$. If $v_2^s \in N(\pi^*, \pi)$, we are done, because then $\phi(\pi^*, \pi) \geq \phi_{\{y_1, y_2\}}(\pi^*, \pi) + \phi_{\{v_1^s, v_2^s\}}(\pi^*, \pi) + \sum_{s' \in S \setminus \{s\}} \phi_{\{v_1^{s'}, v_2^{s'}\}}(\pi^*, \pi) + \phi_{T_0^1}(\pi^*, \pi) \geq 0 + 2 + 0 + 1 = 3$. Now, if $C \cap \{b_k^j : j \in [R]\} = \{b_k^i\}$, then $v_{v_2^s} \leq \frac{\frac{21}{10}(k+1) + \frac{3}{5}(k+1)}{5} < \frac{21}{20}(k+1) = v_{v_2^s}(\pi^*)$, but we already excluded that. Thus, there is $i' \neq i$ with $b_k^{i'} \in C$. It is easy to see that $b_k^{i'} \in N(\pi^*, \pi)$, which is contradicting our assumption that $\{b_k^i : i \in [2^k]\} \subseteq N(\pi, \pi^*)$. This concludes the case that $v_1^s \in C$ and we assume henceforth that, for all $s \in S'$, $v_1^s \notin C$.

Let $I = s \cap \{r^i \in R : b_k^i \in C\}$ the set of members of s whose corresponding agents are in the coalition C . If $|I| \leq 2$, then $v_{v_2^s}(\pi) \leq \frac{\frac{6}{3}(k+1)}{3} = k+1 < \frac{21}{20}(k+1) = v_{v_2^s}(\pi^*)$. However, it is already excluded that $v_2^s \in N(\pi^*, \pi)$. Hence, $|I| = 3$. In other words, $\pi(v_2^s) = \{v_2^s, b_k^i, b_k^j, b_k^w\}$ with $s = \{i, j, w\}$. We conclude that S' is a 3-partition of R by sets in S .

We will now proceed with the proof of the induction claim.

For the base case $j = k$, fix $i \in [2^k]$ and assume that $A_k^i \notin \pi$. We observe that if $A_k^i \cap N(\pi, \pi^*) \neq \emptyset$, then clearly $\phi_{A_k^i}(\pi^*, \pi) \geq 1$. If $A_k^i \cap N(\pi, \pi^*) = \emptyset$, then $\{a_k^i, c_k^i\} \subseteq N(\pi^*, \pi)$ and $\phi_{A_k^i}(\pi^*, \pi) \geq 1$. If in addition $\{b_k^i, a_k^i\} \cap \pi(c_k^i) = \emptyset$, then $b_k^i \in N(\pi^*, \pi) \cup N(\pi, \pi^*)$ and the first part of the claim follows.

For the induction step, let $j \in \{k-1, \dots, 0\}$ and fix $i \in [2^j]$. Assume first that there exists an agent $z \in T_j^i$ with $\pi(z) \neq \pi^*(z)$ but no such agent in A_j^i . The premise of the first claim is vacuous and this part is therefore true. Since $z \in T_{j+1}^{2i-1} \vee z \in T_{j+1}^{2i}$, we can apply induction for the second claim since the premise of the second claim for T_{j+1}^{2i-1} or T_{j+1}^{2i} is true. Assume therefore that there exists an agent $z \in A_j^i$ with $\pi(z) \neq \pi^*(z)$.

We make the following observations.

- If $\alpha_j^i \in N(\pi, \pi^*)$, then $\beta_j^i \in N(\pi^*, \pi)$.
- If $\beta_j^i \in N(\pi, \pi^*)$, then $\alpha_j^i \in N(\pi^*, \pi)$.
- If $\gamma_j^i \in N(\pi, \pi^*)$, then $\delta_j^i \in N(\pi^*, \pi)$.

- If $\delta_j^i \in N(\pi, \pi^*)$, then $\gamma_j^i \in N(\pi^*, \pi)$.

Now, we consider the case that $\pi(a_j^i) \neq \pi^*(a_j^i)$.

- We consider first the subcase that $b_j^i \in N(\pi, \pi^*)$. Then $c_j^i \in N(\pi^*, \pi)$.
 - If $\pi(b_j^i) \supseteq \{c_{j+1}^{2i-1}, c_{j+1}^{2i}\}$, then $\phi_{A_j^i}(\pi, \pi^*) \leq 1$ (with the above observations), while by induction $\phi_{T_{j+1}^{2i-1} \cup T_{j+1}^{2i}}(\pi^*, \pi) \geq 2$ and $\phi_{T_{j+1}^{2i-1} \cup T_{j+1}^{2i}}(\pi^*, \pi) \geq 4 \vee \{b_k^i : i \in [2^k]\} \cap (T_{j+1}^{2i-1} \cup T_{j+1}^{2i}) \subseteq N(\pi, \pi^*)$ and we are done.
 - Otherwise, $c_j^i \in \pi(b_j^i)$ and $\pi(b_j^i) \cap \{c_{j+1}^{2i-1}, c_{j+1}^{2i}\} \neq \emptyset$. Then $\phi_{A_j^i}(\pi^*, \pi) \geq 1$ or $a_j^i \in N(\pi, \pi^*)$. We only need to consider the second case. Assume for contradiction that $a_j^i \in \pi(b_j^i)$. Then, $\pi(b_j^i) \cap \{\beta_j^i, \gamma_j^i\} \neq \emptyset$ (otherwise, $a_j^i \in N(\pi^*, \pi)$). Then, $v_{b_j^i}(\pi) \leq \frac{3j+4}{5} < \frac{2j+2.5}{3} = v_{b_j^i}(\pi^*)$, contradicting our assumption on b_j^i (note that we used that $\pi(b_j^i) \not\supseteq \{c_{j+1}^{2i-1}, c_{j+1}^{2i}\}$). Therefore, $a_j^i \notin \pi(b_j^i)$ and therefore $\pi(a_j^i) = \{\alpha_j^i, \beta_j^i, \gamma_j^i\}$. Hence, $\phi_{A_j^i}(\pi^*, \pi) \geq 1$ or $\pi(\delta_j^i) = \{\delta_j^i, \alpha_{j+1}^{2i-1}, \alpha_{j+1}^{2i}\}$. But then $\phi_{A_j^i}(\pi^*, \pi) \geq -1$ and $\phi_{T_{j+1}^{2i-1} \cup T_{j+1}^{2i}}(\pi^*, \pi) \geq 2$ and we are done.
- We can even assume that $b_j^i \in N(\pi^*, \pi)$, since otherwise $a_j^i \in \pi(b_j^i)$ and $a_j^i, c_j^i \in N(\pi^*, \pi)$ and it follows $\phi_{A_j^i}(\pi^*, \pi) \geq 1$.
- If $c_j^i \in N(\pi, \pi^*)$, then $a_j^i, b_j^i \in N(\pi^*, \pi)$ and therefore $\phi_{A_j^i}(\pi^*, \pi) \geq 1$ and we are done.
- Since $\pi(c_j^i) \neq \pi^*(c_j^i)$, we can assume $c_j^i \in N(\pi^*, \pi)$
- Next, consider the case that $a_j^i \in N(\pi, \pi^*)$ and, by the previous cases, $c_j^i, b_j^i \in N(\pi^*, \pi)$.
 - If $\pi(a_j^i) = \{\alpha_j^i, \beta_j^i, \gamma_j^i\}$, then $\phi_{A_j^i}(\pi^*, \pi) \geq 3$ or $\pi(\delta_j^i) = \{\delta_j^i, \alpha_{j+1}^{2i-1}, \alpha_{j+1}^{2i}\}$. In the latter case, $\phi_{A_j^i}(\pi^*, \pi) \geq 1$ and $\phi_{T_{j+1}^{2i-1} \cup T_{j+1}^{2i}}(\pi^*, \pi) \geq 2$ by induction and we are done.
 - Otherwise, $\beta_j^i \in \pi(a_j^i) \cap N(\pi^*, \pi)$ or $\gamma_j^i \in \pi(a_j^i) \cap N(\pi^*, \pi)$. In the former case, $\alpha_j^i \in N(\pi^*, \pi)$ and in total $\phi_{A_j^i}(\pi^*, \pi) \geq 3$. In the latter case, again, $\phi_{A_j^i}(\pi^*, \pi) \geq 3$ or $\pi(\delta_j^i) = \{\delta_j^i, \alpha_{j+1}^{2i-1}, \alpha_{j+1}^{2i}\}$ and the case is similar as before.
- Note that a_j^i is not indifferent between $\pi(a_j^i)$ and $\pi^*(a_j^i)$, because $\pi(a_j^i) \neq \pi^*(a_j^i)$. It remains that $a_j^i, b_j^i, c_j^i \in N(\pi^*, \pi)$, in which case $\phi_{A_j^i}(\pi^*, \pi) \geq 3$.

We may therefore assume that $\pi(a_j^i) = \pi^*(a_j^i)$. Only for the remaining cases, we need that $\alpha_j^i \notin N(\pi, \pi^*)$. If $\pi(\alpha_j^i) \neq \pi^*(\alpha_j^i)$, then $\alpha_j^i, \beta_j^i \in N(\pi^*, \pi)$ and consequently $\phi_{A_j^i}(\pi^*, \pi) \geq 2$. If $\pi(\gamma_j^i) \neq \pi^*(\gamma_j^i)$, then $\phi_{A_j^i}(\pi^*, \pi) \geq 2$ or $\phi_{A_j^i}(\pi, \pi^*) \geq 0 \wedge \pi(\delta_j^i) \cap \{\alpha_{j+1}^{2i-1}, \alpha_{j+1}^{2i}\} \neq \emptyset$ and the claim follows by induction.

For the second part of the lemma, assume that S' is a 3-partition of R through sets in S . Define

$$\begin{aligned} \pi' = & \{ \{b_k^v, b_k^w, b_k^x, v_2^s\}, \{v_1^s\} : \{v, w, x\} = s \in S' \} \cup \{ \{v_1^s, v_2^s\} : s \in S \setminus S' \} \\ & \cup \{ \{b_k^{|R|+1}, \dots, b_k^{2^k}, y_2\}, \{y_1\} \} \cup \{ \{\delta_{k-1}^i, \alpha_k^{2i-1}, \alpha_k^{2i}\} : i \in [2^{k-1}] \} \\ & \cup \{ \{b_j^i, c_{j+1}^{2i-1}, c_{j+1}^{2i}\}, \{a_j^i, \beta_j^i, \gamma_j^i\} : j \in [k-1], i \in [2^j] \} \\ & \cup \{ \{\delta_j^i, \alpha_{j+1}^{2i-1}, \alpha_{j+1}^{2i}\} : j \in [k-2], i \in [2^j] \} \cup \{ \{\alpha_0^1\}, \{c_0^1\} \}. \end{aligned}$$

It is easily checked that $\phi(\pi', \pi^*) = 1$ and c_0^1 forms a singleton coalition with $c_0^1 \in N(\pi^*, \pi')$. \square

The proof of the hardness of the existence of strongly popular partitions on FHGs is very similar to the case of ASHG, but there are some subtle differences regarding the preferences of the additional agent.

Theorem 23. *Checking whether there exists a strongly popular partition in a symmetric FHG is coNP-hard, even if all utilities are non-negative.*

Proof. The reduction is from X3C. Given an instance (R, S) of X3C, we consider the symmetric, non-negative FHG of Lemma 6 on agent set N with utility function v together with the partition π^* and the special agent $x \in N$. We define a symmetric, non-negative FHG on agent set $N' = N \cup \{z\}$ where the utilities are given by $v'(y, w) = v(y, w)$ if $y, w \in N$, $v'(z, x) = v_x(\pi^*)/2$, and $v'(z, y) = 0$ for $y \in N \setminus \{x\}$. Note that by Lemma 6, this reduction is in polynomial time.

Consider the partition $\sigma^* = \pi^* \cup \{\{z\}\}$ and let a partition $\sigma \neq \sigma^*$ of N' be given. Define $\pi = (\sigma \setminus \sigma(z)) \cup \{\sigma(z) \setminus \{z\}\}$. Note that every agent $y \in N \setminus \{x\}$ can only improve her utility if z leaves her coalition. In addition, the utility $v(x, z)$ is designed so that x still receives her unique top-ranked coalition in σ^* (apply Proposition 10). Hence, $\phi_N(\sigma^*, \sigma) \geq \phi(\pi^*, \pi)$.

We consider the popularity margin between σ^* and σ by a case distinction. If $\pi \neq \pi^*$, then $\phi(\sigma^*, \sigma) \geq -1 + \phi(\pi^*, \pi) \geq 0$ and $\phi(\sigma^*, \sigma) > 0$ if (R, S) is a ‘no’-instance. On the other hand, if $\pi = \pi^*$, then $\sigma(z) \neq \{z\}$ (since $\sigma \neq \sigma^*$). As $v_y(\pi^*) > 0$ for all $y \in N$, we know that $|\sigma(z) \setminus \{z\}| \geq 2$ and $y \in N(\sigma^*, \sigma)$ for all $y \in \sigma(z) \setminus \{z\}$ (by design of the utilities, this holds in particular for agent x). Hence, $\phi(\sigma^*, \sigma) = \phi_{\sigma(z)}(\sigma^*, \sigma) \geq -1 + |\sigma(z) \setminus \{z\}| > 0$

It follows that σ^* is popular and it is a strongly popular partition if (R, S) is a ‘no’-instance.

If (R, S) is a ‘yes’-instance, then σ^* is the only candidate that might be strongly popular. Consider the partition π' from Lemma 6 and define $\sigma' = (\pi' \setminus \{\{x\}\}) \cup \{\{x, z\}\}$. Then, $x \in N(\pi^*, \pi') \cap N(\sigma^*, \sigma')$, whereas $z \in N(\sigma', \sigma^*)$. Therefore, $\phi(\sigma', \sigma) = 1 + \phi(\pi', \pi^*) = 0$. Hence, π^* is not strongly popular and there exists no strongly popular partition. \square

Theorem 24. *Verifying whether a given partition in a symmetric FHG is strongly popular is coNP-complete, even if all utilities are non-negative.*

Proof. In the proof of Theorem 17, the partition σ^* is strongly popular if, and only if, (R, S) is a ‘no’-instance of X3C. \square

Theorem 25. *Computing a mixed popular partition in a symmetric FHG is NP-hard, even if all utilities are non-negative.*

Proof. We give a Turing reduction from X3C. Given an instance (R, S) of X3C, we consider the symmetric FHG of Lemma 6 on agent set N with utility function v together with the partition π^* and the special agent $x \in N$. We define a symmetric, non-negative FHG on agent set $N' = N \cup \{z_1, z_2\}$ where the utilities are given by $v'(y, w) = v(y, w)$ if $y, w \in N$, $v'(z_1, z_2) = v_x(\pi^*)/2$, $v'(z_1, x) = v'(z_2, x) = v_x(\pi^*)/3 > 0$, and $v'(z_i, y) = 0$ for $i \in [2], y \in N \setminus \{x\}$. Note that by Lemma 6, this reduction is in polynomial time.

Consider the partition $\sigma^* = \pi^* \cup \{\{z_1, z_2\}\}$ and let $\sigma \neq \sigma^*$ be given. Define $\pi = (\sigma \setminus (\sigma(z_1) \cup \sigma(z_2))) \cup \{\sigma(z_1) \setminus \{z_1, z_2\}, \sigma(z_2) \setminus \{z_1, z_2\}\}$, that is, the partition of agent set N where z_1 and z_2 leave their coalitions. Assume that (R, S) is a ‘no’-instance. We will prove that $\phi(\sigma^*, \sigma) > 0$, and therefore that σ^* is strongly popular. We may assume that $\sigma(z_1) = \{z_1, z_2\}$ or $x \in \sigma(z_i)$ for some i , because otherwise it is a Pareto improvement if z_1 and z_2 leave their coalitions and form a coalition of their own.

Note that as in the proof of Theorem 23, it holds that $\phi_N(\sigma^*, \sigma) \geq \phi(\pi^*, \pi)$. Now, for $i \in [2]$ holds that $z_i \in N(\sigma^*, \sigma)$ unless $\sigma(z_i) \in \{\{z_1, z_2, x\}, \{z_1, z_2\}\}$. If $\sigma(z_i) = \{z_1, z_2\}$, then $\phi(\sigma^*, \sigma) = \phi(\pi^*, \pi) \geq 1$, because $\pi \neq \pi^*$. On the other hand, $\sigma(z_i) = \{z_1, z_2, x\}$, then $\pi(x) \cap \pi^*(x) = \{x\}$ and it follows that $\phi(\sigma^*, \sigma) \geq -2 + \phi(\pi^*, \pi) \geq 1$ (where the last inequality uses Lemma 6). It remains the case that $z_1, z_2 \in N(\sigma^*, \sigma)$ and we obtain $\phi(\sigma^*, \sigma) \geq 2 + \phi(\pi^*, \pi) \geq 2$. Together, the partition σ^* is strongly popular and therefore, the unique mixed popular partition consists of σ^* with probability 1.

Now assume that (R, S) is a ‘yes’-instance. Consider the partition π' from Lemma 6 and define $\sigma' = (\pi' \setminus \{\{x\}\}) \cup \{\{x, z_1, z_2\}\}$. Then, $x \in N(\pi^*, \pi') \cap N(\sigma^*, \sigma')$, whereas $z_1, z_2 \in N(\sigma', \sigma^*)$. Therefore, $\phi(\sigma', \sigma) = 2 + \phi(\pi', \pi^*) = 1$. Hence, the pure mixed partition $\{\sigma^*\}$ is not mixed popular.

We can solve X3C by computing a partition σ in the support of a mixed popular partition and checking its probability in case that $\sigma = \sigma^*$. \square

Theorem 26. *Checking whether there exists a popular partition in a symmetric FHG is coNP-hard, even if all utilities are non-negative.*

Proof. We provide a reduction from X3C. Given an instance (R, S) of X3C, we consider the symmetric FHG with non-negative utility functions of Lemma 6 on agent set N with utility function v together with the partition π^* and the special agent $x \in N$. Set $\alpha = v_x(\pi^*)$. For $i \in [2]$, let $N_i = \{y_i : y \in N\}$ be two copies of N . Accordingly, let π_i^* be their respective copies of π^* .

We define a symmetric ASHG on agent set $N' = N_1 \cup N_2 \cup Z$ where $Z = \{z_k^j : k \in [2], j \in [3]\}$. Define $Z^j = \{z_1^j, z_2^j\}$. Utilities are as follows.

- $v'(y_i, w_i) = v(y, w)$ if $y, w \in N_i$ for $i \in [2]$,
- $v'(z_k^j, x_1) = 2\alpha/5$, $v'(z_k^j, x_2) = \alpha/3$ for $k \in [2], j \in [3]$,
- $v'(z_1^j, z_2^j) = \alpha/2$ for $j \in [3]$, and
- $v'(u, y) = 0$ for every pair of agents $u, y \in N'$ such that their utility is not yet defined.

By Lemma 6, this reduction is in polynomial time.

First assume that (R, S) is a ‘no’-instance. We claim that $\sigma^* = \pi_1^* \cup \pi_2^* \cup \{Z^j : j \in [3]\}$ is popular. To prove this, let $\sigma \neq \sigma^*$ be an arbitrary partition and define $\pi_i = \{\sigma(y) \cap N_i : y \in N_i\}$ be the coalitions restricted to N_i . Let $k \in [2]$ and $j \in [3]$. The first key insight is that if there exists $y \in \sigma(z_k^j) \setminus (Z^j \cup \{x_1, x_2\})$, then $z_k^j \in N(\sigma^*, \sigma)$. Assume that such an agent y exists. Observe that the only agents that provide positive utility to z_k^j are z_{3-k}^j, x_1 , and x_2 . The maximum utility that under these circumstances can be obtained for z_k^j is $\sigma(z_k^j) = \{z_k^j, z_{3-k}^j, x_1, y\}$ and even in this case $v_{z_k^j}(\sigma) = \frac{\alpha/2 + 2\alpha}{5} = \frac{9\alpha}{40} < \frac{\alpha}{4} = v_{z_k^j}(\sigma^*)$.

We will use this insight to show that we can assume for every $k \in [2], j \in [3]$ that $\sigma(z_k^j) \subseteq Z^j \cup \{x_1, x_2\}$. Fix again $k \in [2], j \in [3]$ and assume otherwise. Then, $\sigma(z_k^j) \cap (Z^j \cup \{x_1, x_2\}) \subseteq N(\sigma^*, \sigma)$. This follows for agents in Z^j from what we have just shown before, and for agents x_i by the design of their utilities and the fact that they received a top-ranked coalition in π_i^* and by Proposition 10 in σ^* . We modify σ by leaving the coalition with the agents in Z^j , that is, we define $\sigma' = (\sigma \setminus \sigma(z_k^j)) \cup \{\sigma(z_k^j) \setminus Z^j, \sigma(z_k^j) \cap Z^j\}$. Then, $N(\sigma^*, \sigma') \subseteq N(\sigma^*, \sigma)$ and $N(\sigma, \sigma^*) \subseteq N(\sigma', \sigma^*)$, which implies that $\phi(\sigma^*, \sigma) \geq \phi(\sigma^*, \sigma')$ and it suffices to consider σ' and show a non-negative popularity margin for that partition.

We are ready to compute the popularity margin. Therefore, define $I = \{i \in [2] : \sigma(x_i) \cap Z \neq \emptyset\}$. Note that for $i \in [2]$, $\phi_{N_i}(\sigma^*, \sigma) \geq \phi(\pi_i^*, \pi_i)$. Furthermore, if $i \in I$, then $\pi_i(x_i) \cap N_i = \{x_i\}$ and $|Z \cap \sigma(x_i)| \leq 2$. It follows that $\phi(\sigma^*, \sigma) = \phi_{N_1}(\sigma^*, \sigma) + \phi_{N_2}(\sigma^*, \sigma) +$

$\phi_Z(\sigma^*, \sigma) \geq \sum_{i \in I} \phi_{N_i}(\pi_i^*, \pi_i) + \sum_{i \notin I} \phi_{N_i}(\pi_i^*, \pi_i) + \phi_Z(\sigma^*, \sigma) \geq 3|I| - |\{z \in Z: \sigma(z) \cap \{x_1, x_2\} \neq \emptyset\}| = 3|I| - 2|I| \geq 0$. Hence, σ^* is popular.

Conversely, assume that (R, S) is a ‘yes’-instance and assume for contradiction that σ is popular and define $\pi_i = \{\sigma(y) \cap N_i: y \in N_i\}$ as above.

The overall proof strategy is as follows. First, we show that for $k \in [2]$ and $j \in [3]$, $\sigma(z_k^j) \in \{Z^j, Z^j \cup \{x_1\}, Z_j \cup \{x_2\}\}$. Then we show, that for $i \in [2]$, there exists $j \in [3]$ with $Z^j \cup \{x_i\} \in \sigma$. Finally, we perform a cyclic exchange of such coalitions.

Let $k \in [2]$ and $j \in [3]$ and define $C = \sigma(z_k^j)$. The first crucial step is to show that $C \subseteq \{x_1, x_2\} \cup Z^j$. To see this, assume for contradiction that there exists an agent $y \in C \setminus (\{x_1, x_2\} \cup Z^j)$. We may assume that $v_y(\sigma) > 0$, since otherwise leaving the coalition with y yields a Pareto-improvement. Recall, that we have shown in the first part of the proof that, under these circumstances, $v_{z_k^j}(Z^j) > v_{z_k^j}(\sigma)$. The same holds for z_{3-k}^j in both the case that $z_{3-k}^j \in C$ and $z_{3-k}^j \notin C$. Define $\sigma' = (\sigma \setminus \{\sigma(z_1^j), \sigma(z_2^j)\}) \cup \{\sigma(z_1^j) \setminus \{z_1^j\}, \sigma(z_2^j) \setminus \{z_2^j\}, Z^j\}$. Then $\{z_1^j, z_2^j, y\} \subseteq N(\sigma', \sigma)$, while $N(\sigma, \sigma') \subseteq \{x_1, x_2\}$. Hence, σ' is more popular, which is a contradiction. It follows that $C \subseteq \{x_1, x_2\} \cup Z^j$.

Next, we claim that $z_{3-k}^j \in \sigma(z_k^j)$. Assume otherwise. If one of z_k^j and z_{3-k}^j is in a singleton coalition, it is a Pareto improvement to form $\sigma(z_k^j) \cup \sigma(z_{3-k}^j)$. Otherwise, there exists $i \in [2]$ with $\sigma(z_k^j) = \{x_i, z_k^j\}$ and if $\sigma(z_{3-k}^j) = \{z_{3-k}^j, x_{3-i}\}$. Hence, if z_{3-k}^j leaves her coalition and joins $\sigma(z_k^j)$, we obtain a more popular partition.

Define $I = \{i \in [2]: Z \cap \sigma(x_i) \neq \emptyset\}$ and let $i \in I$. We claim that there exists $j \in [3]$ with $\sigma(x_i) = \{x_i\} \cup Z^j$. Let $k \in [2], j \in [3]$ with $z_k^j \in \sigma(x_i)$. We already know that then $Z^j \subseteq \sigma(x_i) \subseteq Z^j \cup \{x_1, x_2\}$. Furthermore, by the pigeon hole principle, for some $j' \in [3] \setminus \{j\}$ holds $Z^{j'} \in \sigma$. Assume for contradiction that $x_{3-i} \in \sigma(x_i)$. Then, $\sigma' = (\sigma \setminus \{\sigma(x_i), Z^{j'}\}) \cup \{Z^j \cup \{x_1\}, Z^{j'} \cup \{x_2\}\}$ is more popular. Indeed, $N(\sigma', \sigma) = \{x_1, x_2, z_1^{j'}, z_2^{j'}\}$, while $N(\sigma, \sigma') = Z^j$.

The remainder of the proof is identical to the proof for ASHG, namely we show that $I = \{1, 2\}$ and find a more popular partition even in this case.

All in all, it is shown that there exists no popular partition if (R, S) is a ‘yes’-instance. This concludes the proof of the theorem. \square

Contact Details

Felix Brandt
 Technische Universität München
 München, Germany
 Email: brandtf@in.tum.de

Martin Bullinger
 Technische Universität München
 München, Germany
 Email: bullinge@in.tum.de